

Televés®



MOSAIQ₆ 

Refs. 596101, 596111

EN Multi-touch Meter / Analyser

User manual

www.televés.com

Index

Index	3	Web application	56
Safety requirements	4	1.- Measurements	56
Symbols and safety labels	4	2. Plans	57
Introducing the MOSAIQ6	5	3. SCR	58
Key features	5	4. Quality profiles	58
General Specifications	6	5. User profiles	59
Technical Specifications	7	6. Clone	59
Description of equipment components	9	7. Licenses	59
Connectors and controls	9	8. Remote control	60
Keyboard	9	9. Configuration	60
Power supply	10	Cloud Repository	60
About the battery	10	Error messages	61
Separately battery charge	11	Technical support	62
Gestures	12	Repair service	62
Before starting	12	Warranty	63
Icons on the screen	14		
Bottom bar	14		
Top bar	15		
Menus	16		
Top Menu	16		
Main Menu	16		
Options context menu	16		
Top menu	16		
Inputs/Outputs	16		
Powering	16		
Settings	17		
Main menu	19		
1. Settings	19		
2. User profiles	21		
3. Optical attenuation	22		
4. Satellite identification	23		
5. LTE check	25		
6. TV Analyser	26		
7. Spectrum analyser	40		
8. Radio Analyser	43		
9. Wi-Fi Analyser	47		
10. Network Tools	49		
11. Drive Test	52		
12. LOGS	54		

Safety requirements

● Product inspection

- Inspect the equipment for shipping damage. Should any damage be discovered, immediately file a claim with the carrier.

● Read and Follow All Instructions

- All the safety and operating instructions should be read prior to and followed while operating this product.

● Do not obstruct the ventilation slots

● Cleaning

- Follow the cleaning instructions contained in the Maintenance section of this manual.

● Attachments

- Do not use attachments that are not approved by the product manufacturer

● Water and Moisture

- This product is splash water resistant but is not submersible.
- Do not place objects filled with liquids on or near the meter, such as glasses.

● Power Sources

- This product should be operated only from the type of power source specified (12VDC - 4A).
- Ensure that the voltage applied to the power connector does not exceed 15V. Higher voltages could damage the equipment
- Maximum consumed current: 4A

● Grounding or Polarization

- Do not bypass or defeat electrical plug polarization or grounding. Doing so will violate the warranty and may pose a risk of fire or electrocution.

● Wire Protection

- Ensure all connected wiring is routed correctly to avoid damage including pinching, excessive bends, or compression.

● Electrical Supply, Grounding, and Surge Protection

- Ensure that all local or national electrical codes are followed.

● Power Lines

- Always use caution and avoid operating this or any connected equipment near uninsulated power lines or any other hazards.

● Servicing

- There are no user serviceable parts except the battery pack. Do not attempt to service this product or remove covers. Refer all servicing to qualified service personnel. Follow the instructions in this manual when replacing the battery.

● Heat

- The product should be situated away from heat sources such as radiators, heat registers, stoves, or other products that produce heat..
- Do not place naked flame sources on the meter, such as lighted candles.

● Battery pack

- Battery must be replaced by the battery pack supplied by the manufacturer (ref. 596210) only. In no case the battery pack cover can be opened.
- This product should be operated only from the type of power source specified (12VDC - 4A).
- Ensure that the voltage applied to the power connector does not exceed 15V. Higher voltages could damage the equipment
- May explode if damaged or disposed of in fire or water

● Class

- Operation of this equipment in a residential environment may cause radio interference.

Symbols and safety labels



Recycle or dispose of used electronic devices properly.



The equipment contains a recyclable battery. Before depositing the equipment in the container of electrical and electronic equipment, you must remove the battery pack and deposit it separately for proper management



Battery can only be replaced by the battery pack supplied by the manufacturer (ref. 596210)

Overview

Introducing the MOSAIQ6

MOSAIQ6 is the new high-performance portable meter, with advanced features and high measurement accuracy. And all in the most automatic and intuitive way in the market, thanks to its intuitive interface and gestural commands.

With **MOSAIQ6**, technicians have a tool to measure, analyse and diagnose radio and TV signals in any scenario, no matter how complex.

MOSAIQ6 has an ultra-fast spectrum analyser with high accuracy, together with the echoes analysis features, allows to detect any important issue of the signal.

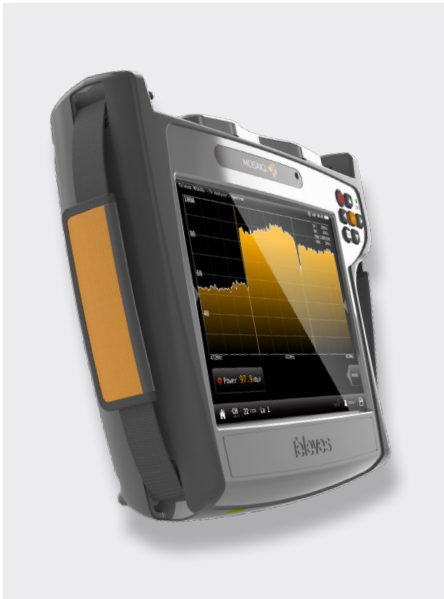

Key features

- **High performance portable meter**
- **Intuitive.** Thanks to its novel interface, designed to get the most out of its multi-touch 8" screen.
- **All the information about the signal in one screen.** Mosaiq feature, with up to 6 widgets configurable by the user.
- **Powerful digital spectrum analyser** (scanning < 10ms.) 5MHz - 3.3GHz range.
- **Easily updateable**
- Spectrum analyser with **selectable span**
- **Specific measurements over IP** (TSolP)
- **PASS/FAIL indicators:** Icons indicate if a measurement is good, bad or in the warning zone for quick and easy status check. Reduce installer entry errors and improve decision making.
- **Field-swappable** and separately rechargeable **battery**
- **User profiles** customization
- Automatic **channel scan**
- Automatic **satellite identification**
- **GPS for drive test** and automatic saving of measurements
- **LTE interferences** detection and simulation

General Specifications

Display	8" Touch Screen TFT 1024x768 Full Colour
Weight	2150g
Dimensions	250x210x60 mm (H x W x D)
Power supply	Input: 100-240V~ 50-60Hz Output: 24VDC, 4A
Battery	Li-ion (7,2VDC, 9000mAh). Field-swappable
Operating time	> 4 hours
Operating temperature	-5°C to 45°C (23°F to 104°F)
Storage temperature	-20°C to 70°C (-4°F to 158°F)
Humidity	5% to 95% without condensation
Interfaces	ETH, USB, HDMI, Audio Out (Jack), FC/APC optical fibre connector, GPS antenna connector
Storage	32 Gb

Technical Specifications

Frequency	
Range	5 - 3300 MHz
Accuracy	1 kHz
Tuning	Frequency or channel
Input	
Impedance	50 Ohm
Spectrum Analyzer	
Span	100 KHz, 1, 5, 10, 20, 50, 100, 200, 500 MHz, 1.0, 2.0 and 3.3 GHz. Other (any value between 100 KHz and 3.3 GHz)
RBW	500 Hz, 1, 3, 5, 10, 30, 50, 100, 300, 500 KHz, 1, 3, 5 MHz
Marks	Up to 4, with delta feature
Event trigger	✓
Waterfall	✓
Hold feature	Maximum and minimum
Reference level	Automatic and manual
Digital measurements DVB-T	
Modulations	COFDM (QPSK, 16QAM, 64QAM)
Power	20 - 128dBuV
CBER	9.9E-2 - 1.0E-6
VBER	1.0E-3 - 1.0E-8
MER	Up to 40dB
C/N	Up to 52dB
Echoes	✓
MER by carrier	✓
Constellation	✓
Uncorrected packets	✓
TILT	✓
Attenuation	✓
Digital measurements DVB-T2	
Modulations	COFDM (QPSK, 16QAM, 64QAM and 256QAM)
Power	20 - 128dBuV
LDPCBER	9.9E-2 - 1.0E-6
BCHBER	1.0E-3 - 1.0E-8
Link Margin	Up to 30dB
MER	Up to 40dB
C/N	Up to 52dB
Echoes	✓
MER by carrier	✓
Constellation	✓
Uncorrected packets	✓
TILT	✓
Attenuation	✓

Multiple PLP	✓
Digital measurements QAM (Annex A/B/C)	
Modulations	4QAM, 16QAM, 32QAM, 64QAM and 256QAM
Power	20 - 128dBuV
BER	1.2E-3 - 1.0E-8
MER	Up to 40dB
C/N	Up to 52dB
Constellation	✓
Uncorrected packets	✓
TILT	✓
Attenuation	✓
Digital measurements ISDB-T/Tb	
Modulations	DQPSK, QPSK, 16QAM and 64QAM
Power	-100 dBm to 20 dBm
C/N	Up to 50 dB
MER	Up to 40dB
Pre-BER (by layer)	1.0E-2 - 1.0E-6
Post-BER (by layer)	9.9E-2 - 1.0E-8
Echoes	✓
Constellation	✓
Uncorrected	✓
TILT	✓
Attenuation	✓
Digital measurements DVB-S	
Wideband (only compatible HW)	230-2300 MHz
Power	20 - 128dBuV
CBER	9.9E-2 - 1.0E-6
VBER	1.0E-4 - 1.0E-8
MER	Up to 20dB
C/N	Up to 30dB
Constellation	✓
Uncorrected packets	✓
TILT	✓
Attenuation	✓
Digital measurements DVB-S2X	
Wideband (only compatible HW)	230-2300 MHz
Modulations	QPSK, 8PSK
Power	20 - 128dBuV
Link Margin	Up to 10dB
MER	Up to 20dB
C/N	Up to 30dB
LDPCBER	9.9E-2 - 1.0E-6
BCHBER	9.9E-2 - 1.0E-8

Specifications are subject to change without notice.

Constellation	✓
Uncorrected packets	✓
TILT	✓
Attenuation	✓
Multi TS	✓
PLS scrambling	✓
Digital measurements DVB-S2	
Wideband (only compatible HW)	230-2300 MHz
Modulations	QPSK, 8PSK, 8APSK, 16 APSK & 32 APSK
Power	20 - 128dBµV
Link Margin	Up to 10dB
MER	Up to 20dB
C/N	Up to 30dB
LDPCBER	9.9E-2 - 1.0E-6
BCHBER	9.9E-2 - 1.0E-8
Constellation	✓
Uncorrected packets	✓
TILT	✓
Attenuation	✓
Multi TS	✓
FM Measurements	
Level	✓
C/N	Up to 52dB
RDS	✓
DAB/DAB+ Measurements (Option 596204)	
Power	De 20 - 128 dBµV
MER	Up to 20 dB
C/N	Up to 30 dB
BER	9.9E-2 – 1.0E-6
Analog Measurements (Option 596203)	
Level	20 - 128dBµV
V/A	Up to 52dB
C/N	Up to 30dB
Features	
Up to 6 widgets user-customizable	✓
System Scan with measurements and learning plan	✓
LTE check (4G/5G)	✓
FO (-40, 7 dBm)	Option 596101
FO Selective (-40, 7 dBm)	Option 596111
GPS Drive Test	Option 596201
MPEG2, MPEG4 Full HD Channels visualization	✓
4K visualization	Option 596205

Info MPEG	SID, VID, AID, Resolution, Profile , Audio Bitrate, Video Bitrate, Resolution info
IPTV Analyzer	✓
Wifi Analyser	2,4 GHz and 5 GHz (Option 596202)
Units	dBµV, dBmV, dBm
Network Tools	✓
Preamp powering	
Preamppowering	5,13, 18, 24Vdc and other (any value between 5 and 24V)
Maximum supplied power	12 W
Maximum supplied current	900 mA
LNB Tone	22 KHz
DISEqC	✓
SCR dCSS (EN50494 EN50607)	✓

Description of equipment components

Connectors and controls

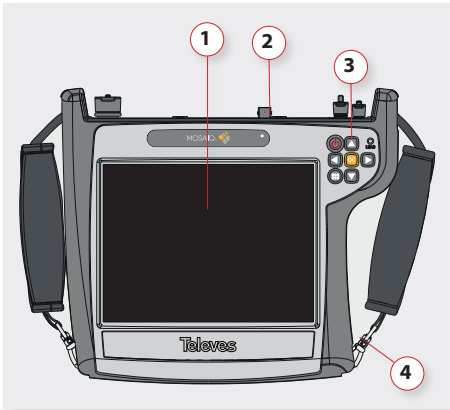

- 1. Touch screen 8"
- 2. Connectors
- 3. Keyboard and LED indicators
- 4. Battery (on the back)

Keyboard

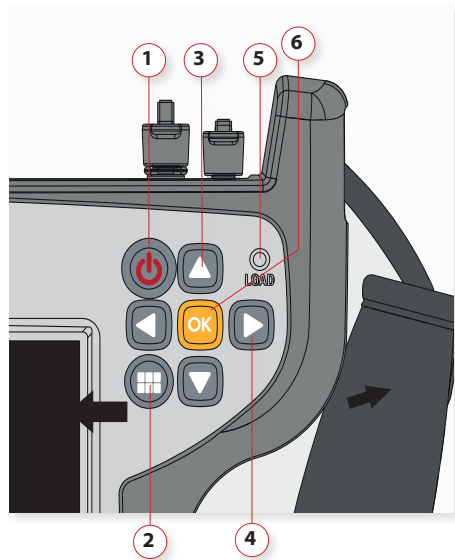

- 1. **Device ON/OFF button:** To turn the equipment off, press and hold for approximately 3 seconds. Short press to lock/unlock the screen.
- 2. **Menu button:** First press-features menu is shown. Second press-context menu is shown. Third press-all menus are hidden.
- 3. **Up/Down buttons:** Changes channel.
- 4. **Left/Right buttons:** Changes screen in multi-screen features.
- 5. **Powering LED:** Indicates if the equipment is powering an external load.
- 6. **OK button:** Short press to accept an option, and press and hold for more than 10 seconds to reset the device.

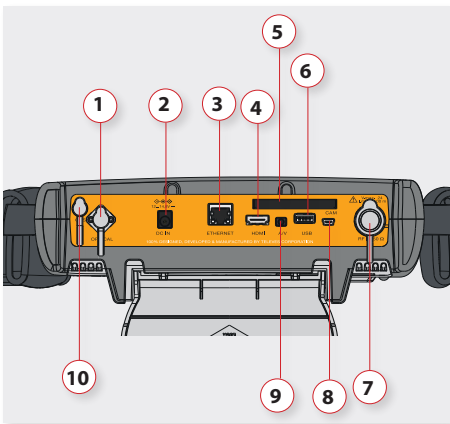

- 1. F.O.
- 2. Power connector
- 3. ETHERNET
- 4. HDMI
- 5. CAM
- 6. USB
- 7. RF Input
- 8. USB
- 9. A/V
- 10. GPS

Power supply

A DC adapter is provided to power and charge the meter. Plug the adapter into a properly grounded electrical supply and the power connector on the side of the unit.

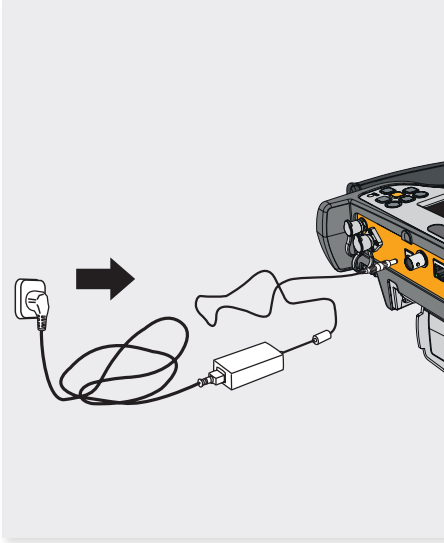

When external power is supplied, the battery management system automatically controls the charging process.

A battery icon indicates the charge status of the battery.

When the battery is fully charged, the battery icon is completely filled. As the battery discharges, the amount the icon is filled decreases in steps.

From a fully discharged state, a full charge takes approximately between 3 and 4 hours. And a 1 hour charge will provide battery for around two working hours.

The charge management system will detect various conditions preventing charging, such as a battery that is over a safe temperature.

About the battery

Important:

If the equipment is going to be stored for a while, it is recommended to take the battery off and store them both separately.

To maximize battery life:

- ▶ Allow fully discharging the battery.
- ▶ The battery can be charged correctly attached to the device and using the supplied DC adapter. Or separately using the DC adapter supplied with the MOSAIQ6.
- ▶ For long term storage, take the battery pack off, and keep the device and the battery pack separately at room temperature, or about 25° C. Start with a charged battery and re-charge the battery every 2 to 3 months.

Battery replacement:

It is recommended to use only the battery packs supplied by the manufacturer to replace the battery, following these instructions:

- ▶ Disconnect the meter from the power supply:

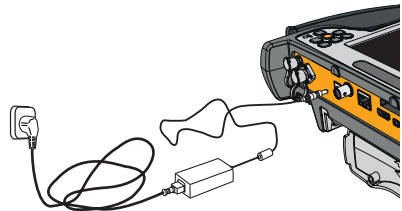

- ▶ Turn the MOSAIQ6 off:

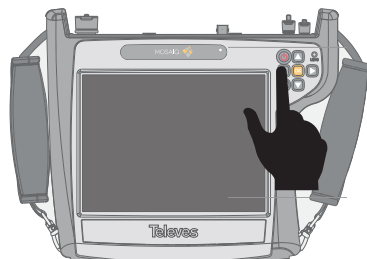

- ▶ The battery pack is placed in the bottom-back side

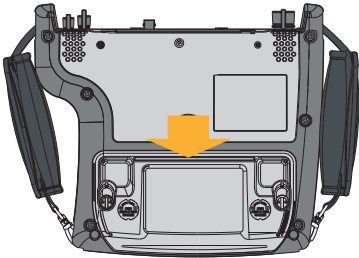

Separately battery charge

The battery can be charged separately from the meter using the DC adaptor supplied with the MOSAIQ6. Plug the adapter into a properly grounded electrical supply and the power connector on the side of the unit.

EN

- ▶ Lift the fixings washers and rotate them 90°. You'll notice that the fixings get out automatically allowing to remove the battery pack

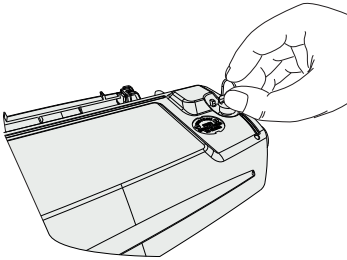

The flashing light indicates that the battery is being charged.

If the battery charge is less than 30% the light is red.

If the battery charge is between 30% and 60% the light is yellow.

If the battery charge is greater than 60% the light is green.

- ▶ Put the new battery pack and rotate the fixings washers again until the fixings fit into the device

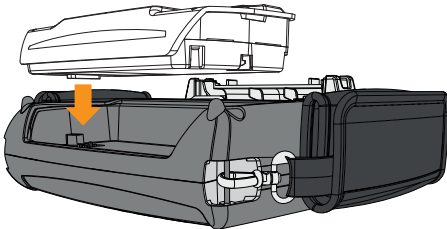

- ▶ Turn you MOSAIQ6 on

Important: never remove the battery as long as your meter is on

Gestures

MOSAIQ6 has an innovative interface, exclusively designed to get the most out of its 8" multi-touch display.

To do this, MOSAIQ6 uses some gestural commands that are explained below:



Tap: one fast touch with one finger.



Double tap: two fast consecutive touches with one finger.



Swipe: short swipe with one finger.



Drag: drag with one finger.



Pinch/Spread: pinch/spread two fingers on the screen.



Drag and drop.

Before starting

The first time you turn you MOSAIQ6 on, please follow the next steps for a proper registration. To do that, you must be registered on the Televés website (www.televés.com).

In addition, you need internet connection (Ethernet or Wi-Fi). Then, please follow the next steps that will be shown on the screen :

1.- Choose the language



2.- Select the internet connection (Ethernet or Wi-Fi):

Tap to select

Activation

You must connect your meter to Internet to complete activation

Choose a network interface to connect to Internet

Ethernet WiFi

Skip Back Next

Skip: cancel the registration. If you skip, you will be prompted to register your meter each time you turn it on
Back: back to previous step
Next: goes to the next step

3.1- If you select Ethernet, all the parameters will appear on the screen: you can enable DHCP mode (the meter will select all the parameters automatically), or disable it (then you must enter all the network parameters)

Indicates that your internet connection works well

Tap to enable/disable DHCP mode

Ethernet

Plug ethernet cable and configure your network

Internet status DHCP ON

IP	192.168.10.280	Mask	255.255.255.0
Gw	192.168.10.249	DNS	1.1.1.131

Skip Back Next

Network parameters

Skip: cancel the registration. If you skip, you will be prompted to register your meter each time you turn it on
Back: back to previous step

3.2- If you select Wi-Fi, a list with all the Wi-Fi networks will appear on the screen. You must select one of them to access the internet.

4- When your MOSAIQ6 is connected to the internet, you have to enter you Televes account data (e-mail and password).

Enter your Televes account data

Activation

Please, login with your credentials from Televes
 You can create a account in <http://www.televes.com>

Login userxx@gmail.com

Password *****

Skip Back Next

Skip: cancel the registration. If you skip, you will be prompted to register your meter each time you turn it on
Back: back to previous step
Next: goes to the next step

5.- Your MOSAIQ6 is registered!

Activation

Please, login with your credentials from Televes
 You can create a account in <http://www.televes.com>

Mosaic registered!

Skip Next

Skip: cancel the registration. If you skip, you will be prompted to register your meter each time you turn it on
Next: goes to the next step

6.- The last step is to enter an alias for your MOSAIQ6, this name will be saved in our database:

Enter an alias for your meter

Alias

EQUIPO SANTIAGO

Skip Next

Skip: cancel the registration. If you skip, you will be prompted to register your meter each time you turn it on
Next: goes to the next step

Icons on the screen

There are always two bars on the screen : one on the top and one on the bottom. The icons in them will be explained below.

Bottom bar:

Tap to direct access to TV Analyser feature

Tap to save LOG

Tap to change tuned Channel/frequency

Tap to change selected profile

Tap to change selected service

Tap to change Band

Tap to change channel-tuning frequency tuning

Tap to create MACROLOG

- Direct access to TV Analyser feature: see section 6.- *TV Analyser*.

- Change channel/frequency: allows you to select another channel (if it is selected channel tuning model) from the channel plan corresponding to the selected user profile, or another frequency (if it is selected frequency tuning mode). See section 2.- *User profiles*.

If it is selected the channel tuning mode, a pop-up window will show all the channels of the channel plan of the user profile (if you haven't do a scan -see section 6.1.- *Scan*-) or a list with the channels found after having made a scan and saved the plan. In the top right side of the channel list, you can see a pencil icon, if you tan on it you can edit the channel list of channels (add or remove channels).

- Change selected service: it allows the user to select any other service locked previously. This feature shows a pop up window with all the services that the user has selected previously in a channel.

Tap on the star to bookmark your favorite services. The favourite services are always in the top of the list

Sort the list by name or by LCN

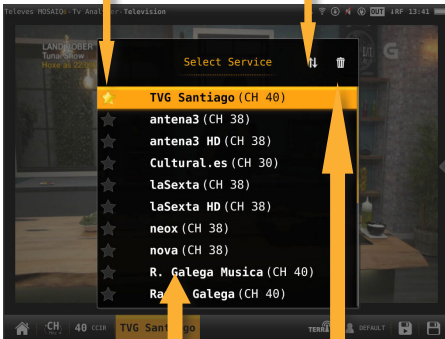

If the selected service is in a channel different from the tuned, the MOSAIQ6 will tune the new channel and select the service automatically

Delete a service from the list

- Change band: see section 2.- *User profiles*
- Change profile: changes the user profile. See section 2.- *User profiles*
- MacroLOG: allows you to schedule repetitive measures in time intervals selected by the user. See section 9.- *LOGs*
- LOG: saves the measurements and the screenshot at that moment. See section 9.- *LOGs*

Top bar:

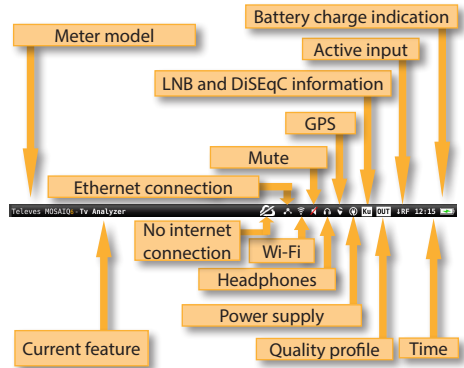

- Connection to the network: indicated that the meter is connected to the network by Ethernet. See section *Settings-Network* in *Top Menu*
- Wi-Fi: indicates that the meter is connected to a Wi-Fi network. See section *Settings-Wi-Fi* in *Top Menu*
- GPS: indicates that the GPS is active. While the satellite data is not received, the icon blinks. See section *Settings-GPS* in *Top menu*. To perform a Drive-Test the GPS must be active, and then schedule a MacroLOG (see icons in the Bottom bar). The results of the Drive Test are shown in the web application. See section 1.- *Measurements* in *Web application*.
- LNB and DiSEqC information: shows information about the LNB band (only if real frequency is selected -see section 1.2.- *Measurements* of the menu 1.- *Settings-*), as well as about DiSEqC if it is active. See section 2.- *User profiles*
- Quality profile: indicates the selected quality profile. To select another quality profile, access the *options context menu* of the feature. See section *Options context menu* in *Menus*. To add new quality profiles see section 5.- *Quality profiles* in *Web application*.
- Enabled input: See section *Inputs/Outputs* in *Top menu*.
- Time: see section *Regional* in the feature 1.- *Settings*

Menus

The MOSAIQ6 has 3 different menus. These menus will be explained in this section briefly, as well as their locations. All their features will be explained in the sections below.

Top Menu



To access this menu you must do a short swipe in the top central part of the screen. The features of this menu allows us to set up certain aspects of the meter in a fast way and from any feature.

Main Menu



To access this menu you must do a short swipe in the right central part of the screen. The main menu is wheel with all the features of the meter. Doing long swipe on the wheel, the user can access every features. To select a feature, you must tap on the corresponding icon.

Options context menu



Most of the features of the main menu have a menu with some options that pertain exclusively to that feature. These options are in a context menu that appears when the user does short swipe in the left central part of the screen.

Top menu

This menu has several tabs that will be explained below. To select one of them, the user must tap on the title.

Inputs/Outputs:

Doing tap on the connector draw, the corresponding input/output will be enabled/disabled. Once it is enabled, the user must set some options depending on the kind of input.

Enabled input

Inputs are green and outputs are blue

Select the setup options doing "tap"

Powering:

Allows setup the preamplifiers powering.



•**Volume:** increases/decreases the volume

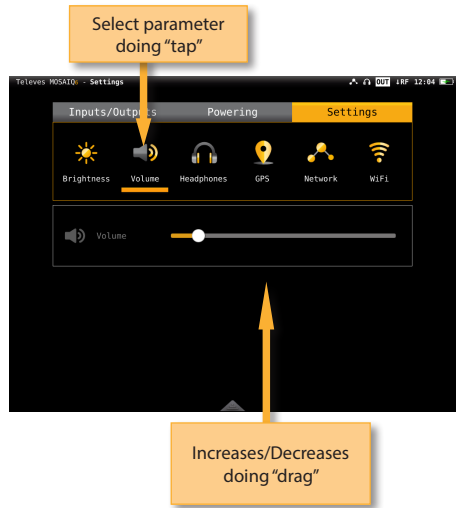

Settings:

The user can set the following parameter from this menu:

•**Brightness:** increase/decrease the display brightness



•**Touch:** increases/decreases the touch control sensitivity

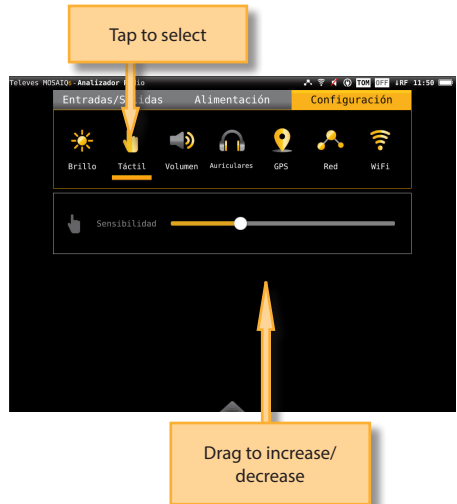

• **Headphones:** enables/disables audio A/V output

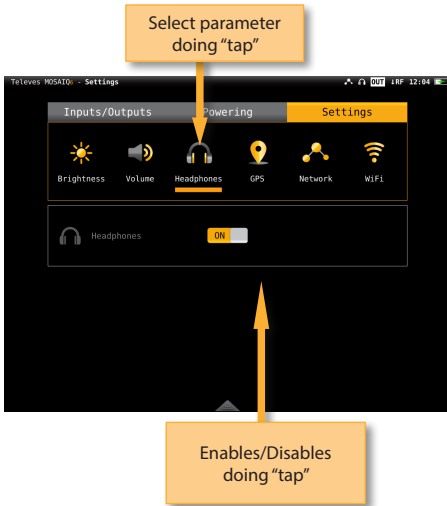

• **GPS:** Enables/disables the GPS feature. When it is enabled, the corresponding icon appears on the top bar of the screen. While the MOSAIQ6 does not receive the satellite signal, the GPS icon will blink.

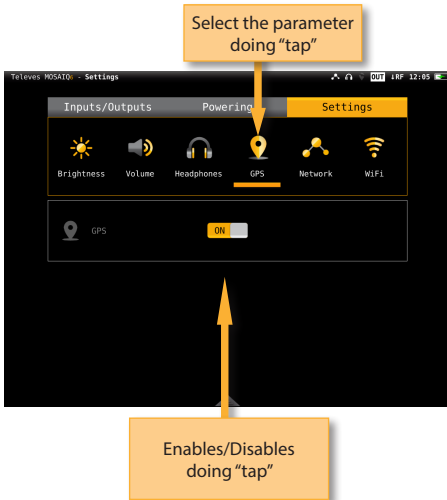

• **Network:** Allows to set up the equipment network connection. If the user selects the DHCP

mode (DHCP ON), the network parameters will be configured automatically. If the DHCP mode is off, the user must type all the network parameters (IP, Gateway, Mask and DNS), and the do tap in "Apply".



• **Wi-Fi:** enables/disables the equipment Wi-Fi connection.



Main menu

All the MOSAIQ6 features are contained in this menu, and they will be explained in the following sections.



1. Settings

Allows set all the global parameters of the meter. This feature has several tabs that will be explained below:

1.1.- Regional

Sets the language, the date and the time.



1.2.- Measures

Allows to set up those parameter that are commons to all the measurements: units, frequency (if real frequency is nos checked, the meter will use IF) and LNB.



1.3.- Energy

Allows set the energy-saving modes. Select the downtime until equipment auto suspension, and the downtime until auto shutdown.



1.4.- Update

When the MOSAIQ6 is connected to the internet (via Ethernet or Wi-Fi) it is automatically detected if a new firmware version is available. If so, tap on the Update button and your MOSAIQ6 will be automatically updated.

Be aware that the meter must be connected to the external powering to be updated.



1.6.- About

Shows all the information about your equipment, both hardware and software.

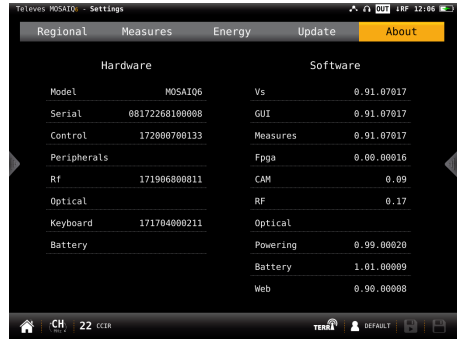

1.5.- Licenses

Shows a list with all the licenses of your MOSAIQ6.

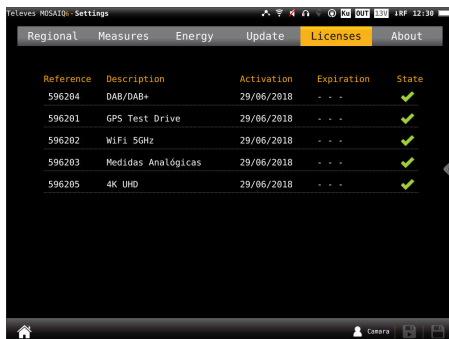



2. User profiles

Your **MOSAIQ6** allows to define as many user profiles as you need. For each user profile, you must indicate what band(s) is going to measure that user profile and the main parameters.

If you select terrestrial band for a profile, you must select the channel plan, the preamplifiers powering and the norm.

If you select satellite band for a profile, you must select the channel plan, polarity, powering, SCR and DiSEqC.

If you select the radio band, you must select the DAB channel plan.

you must select the bands you want to include in that profile and set up the parameters.

To select a band, you must select the corresponding check box. The first step is the terrestrial band, then tap on "Next" button pass to the satellite band, and finally the radio band.

Once you have finished the radio band configuration, tap on "add" button to save the user profile.



2.1.- Set

Goes to the setting feature of the main menu (see section 1.- Settings)

2.2.- Add

Adds a new user profile. When you tap on this button, a popup window will open where the user must set all the required parameters.

First of all, you must type the profile's name. Then

If you include the satellite band in the profile, you must select how many satellites you want to include in that profile. Then you must set all the parameters for each one.

Each satellite plan is automatically associated with a DiSEqC command (first plan with SAT A, second plan with SAT B, and so on). So, the powering is always ON and automatically set to AUTO, but the user can select any other value.

Tap to select/deselect the band

Select the number of satellites

Configure all the necessary parameters for each satellite

Tap to continue to the next band

Tap to cancel

2.3.- Edit

Allows changes in the selected profile of the list. The process is similar to add a new profile.

2.4.- Delete

Deletes the selected profile from the list.



3. Optical attenuation

This feature allows to measure the optical attenuation in the fibre network in three wavelengths: 1310nm, 1490nm and 1550nm. When the user selects this features, the optical fibre input is automatically enabled.

3.1.- Main window:

Bar graph that represents the attenuation of each wavelength

Enabled O.F. input icon

List with the measurements in each wavelength: attenuation, power and reference Tap to select

λ (nm)	Attenuation (dB)	Power (dBm)	Reference (dBm)
1310	0.4	-74.8	-74.4
1490	0.4	-75.7	-75.3
1550	0.5	-75.7	-76.2

3.2.- Options context menu:

Options context menu showing 'Calibrate', 'Units: dBm', and a table of measurements.

Attenuation (dB)	Power (dBm)	Reference (dBm)
0.1	-74.3	-74.4
0.1	-75.4	-75.3
0.1	-76.3	-76.2

•Calibrate: select the wavelength (tap on the graphic or on the list) and tap on this button to calibrate it.

•Units: mW/ μ W, dBm.



4. Satellite identification

This feature is able to detect automatically the satellite the input signal belongs to.

4.1.- Main window

EN

The Mosaiq6 adjusts automatically all the parameters of the spectrum

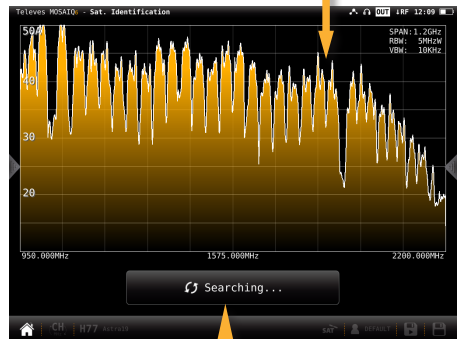

Once the satellite is identified, the name is shown in the display

4.2.- Options context menu

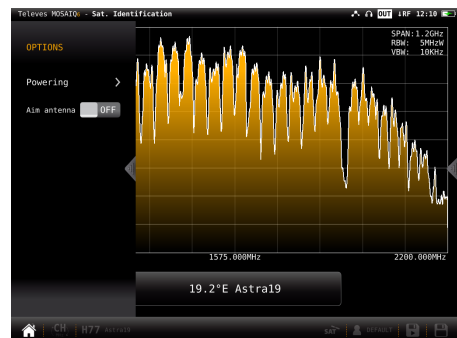

•Powering:

- VDC: Selects the preamplifier powering.
- DiSEqC (only satellite band): selects the DiSEqC parameter (Sat A, Sat B, Sat C, Sat D).
- Positioner (only satellite band): makes it

possible to control the DiSEqC motors used to move mobile parabolic antennas. This function is available in satellite mode and when the equipment is powering the LNB.

Halt: This command stops the motor movement.

East: Allows to move the motor in the EAST direction. Each click corresponds to one step in the movement of the motor (pitch motors). By holding the key down, successive movement sequences will be executed until the key is released.

West: Motor movement in the WEST direction. Each click corresponds to one step in the movement of the motor (pitch motors). By holding the key down, successive movement sequences will be executed until the key is released.

Store: 8 storage positions are available to store at up to 8 antenna positions. This command allows one of 8 positions to be chosen where the current position of the antenna will be stored.

Goto: recovers one of the 8 positions for the antenna that has been previously stored

- **SCR (only satellite band):** Selects the SCR parameters (multiswitch, standard and slots) When a slot is enabled (for example slot 3, freq. 1210MHz), the meter will tune into the slot frequency (1210MHz) and will set the slot with the meter parameters: frequency, band (powering), and DiSEqC. In addition, a SCR icon will be shown in the bar at the top (SCR3) to indicate that the slot is enabled. While the slot is enabled, all the setting changes of the meter, will be applied to the currently slot (SCR3).

• **Aim antenna:**

Emits a modular audible signal with frequency directly proportional to signal level in the spectrum trace relative to reference level. It is recommended to set the reference level manually, as well as to select the span to include a frequency range wide enough. The audible signal becomes continuous when the signal level is close to the reference level. Then it is necessary to increase the reference level to get a more accurate adjustment. This is

a useful feature to point antennas without having to look at the display



5. LTE check

The presence of signals in 4G and 5G bands in distribution systems DTT, can affect the quality of the TV signal.

This function makes an analysis of the 4G and 5G signals and its influence on digital terrestrial television signal (UHF band), and it also estimates the need to insert a filter at the input of a Digital Terrestrial Television (DTT) system, in order to minimize interferences that may cause the signal on the DTT signal.

When you select this function, only the 4G Downlink and the 4G Uplink bands are analysed. You must display the Options Context Menu to analyse the 5G band.

5.1.- Main window

Simultaneous representation of the high UHF band spectrum (closest to the LTE band), LTE down-link spectrum, and LTE up-link spectrum

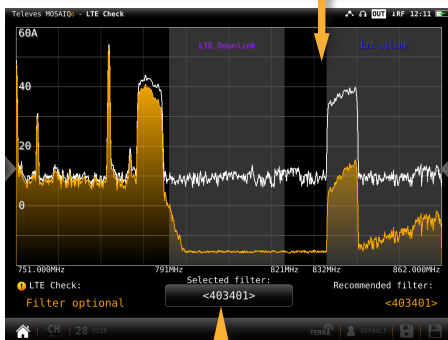

Televés filter recommended by the meter

If it is necessary to insert a filter, is indicated on the screen.

If it was not necessary to insert a filter, it will be displayed the text "LTE Check OK" instead of "Required LTE filter".

On the screen are displayed simultaneously: 1- The

- 1- The spectrum of the high "UHF" band (closest to the LTE band);
- 2- The spectrum of the LTE down-link;
- 3- And the spectrum of the LTE up-link.

In addition to the recommended filter, you can select various filters Televés LTE and display the simulation of how the system would respond with a LTE filter inserted on its input (orange graphic). Use the rotary selector to choice each one of the available filters.

The selected filter is displayed in the bottom center of the screen, there is also the option of not selecting a filter.

5.2.- Options context menu

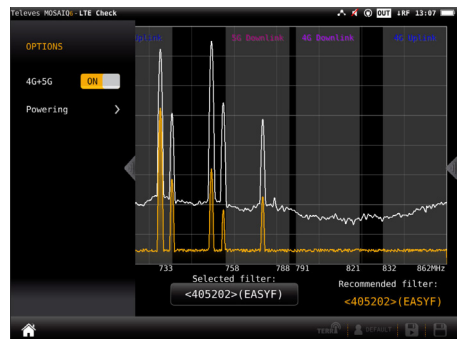

•4G+5G: ON/OFF. When ON is selected, the function analyses the 4G up and down links, as well as the 5G up and down links, detecting possible interfering signals and, if it is necessary it recommends a filter.

•Powering:

- VDC: Selects the preamplifier powering.



6. TV Analyser

This is the main function of the **MOSAIQ6**. The user can reach this function by tapping the icon .

Thanks to this feature it is possible to have in one screen all the information of the tuned signal. The feature TV Analyser has 3 screens: Scan, Mosaiq 3+1 & Mosaiq 6. To switch between screens do long swipe.



Bellow there is a detailed explanation of each of these screens:

6.1.- Scan

This function scans the selected channel plan and detects every existing analog and digital channel in real time to determine the overall frequency response of the system.

The scan measurement leverages the location based thresholds to clearly show whether or not signal levels comply with the cable system's specifications with their green, yellow and red bars.

6.1.1.- Main window

Bar graph representing all the found channels

Banda Tap to select

Tap to access to the options menu

Signal spectrum

List with channels and measurements

CH	Freq(MHz)	Type	Pwr(dBV)	C/N(dB)	VA/MER(dB)	CBER
22	482.000	DVB-T	57.6	40.2	29.8	3.6E-3
23	490.000	DVB-T	48.7	26.5	23.8	4.5E-3
24	498.000	DVB-T2	63.7	42.8	35.9	<1.0E-6
26	514.000		64.0	42.2		
28	530.000	ANALOG	55.5	136.9	>30.0	

Tapping on the icon  a popup window will appear showing the following functions:

Selected channel
Change tapping on the bar graph or on the channel table

Band Tap to select

Channel table with found channels
Vertical drag to see them all

Options buttons (tap)

Bar graph with the channels found in the last scan

CH	Freq(MHz)	Type	Level	C/N	Num. of channels
CH 56	754.000 MHz	ANALOG	55.3 dBV	43.5 dB	14 (Digital: 10, Analog: 4)

CH	Freq(MHz)	Type	Level	C/N	Num. of channels
22	482.000 MHz	DVB-T	57.6	40.2	3
23	490.000 MHz	DVB-T	48.7	26.5	3
24	498.000 MHz	DVB-T2	63.7	42.8	3
26	514.000 MHz		64.0	42.2	
28	530.000 MHz	ANALOG	55.5	136.9	14
40	620.000 MHz	DVB-T			
42	642.000 MHz	DVB-T			
45	666.000 MHz	DVB-T			
48	690.000 MHz	DVB-T			
53	730.000 MHz	ANALOG			
56	754.000 MHz	ANALOG	55.3	43.5	14
59	778.000 MHz	DVB-T			
60	786.000 MHz	DVB-T			

- Start: Starts a new system scan
- Options:
 - Fast: ON/OFF. When the fast scan is enabled (ON), the meter will not make CBER and VBER measurements for digital channels, neither V/A measurements for analog channels. So, only power and level measurements will be shown.
 - Wide outlet: ON/OFF. Enable this option when the outlet in your installation has both terrestrial and satellite bands. So, both bands will be scanned consecutively. If this options is disabled, only the selected band will be scanned.
Note: Note that if the selected user profile does not allow to make measurements in some bands, the scan will not be done in that band.
- Edit: Allows to add/delete channels from the plan. If the channel is selected (orange coloured), when you tap on it, it will be deselected. Otherwise, if the channel is unselected (grey coloured), when you tap on it, it will be selected.
- Save: Saves a new plan with the found channels.
- Cancel: Closes the options window.

•Wide outlet: ON/OFF. Enable this option when the outlet in your installation has both terrestrial and satellite bands. So, both bands will be scanned consecutively. If this options is disabled, only the selected band will be scanned.

Note: Note that if the selected user profile does not allow to make measurements in some bands, the scan will not be done in that band.

•Show all: ON/OFF. When show all is ON, all the measurements of all the channels are shown. When it is OFF, you can only see the measurements of the channel that is being measured in that moment.

•Span full: ON/OFF. When Span full ins ON you can see all the bars corresponding to all the found channels. When this option is OFF, only 24 bars are shown, so it is necessary to scroll to see them all.

•Tilt: ON/OFF. When the tilt option is ON, this function measures the tilt between the channels indicated in the labels CH A and CH B. Then you can see a white line between these two channels and the tilt measurement on it.

•Attenuation: ON/OFF. When the attenuation option is ON, the MOSAIQ6 measures the attenuation of the installation relative to a reference point, usually the head-end output. So, the first thing you must do is connect the meter to the reference point and tap on the Calibrate button. In this way, the equipment will measure and save the level of all the channels.

Then you must go to all the pints of the installation where we want to measure and connect the meter, taking care to have this function ON. The MOSAIQ6 will measure the levels of all the channels comparing them with the reference ones.

When this option is ON, the bars of the graphic don't represent the level or the power of the channels, but the attenuation of each one of them. The list shows power (or level) and C/N. In addition, a green trace is shown in the spectrum. This trace indicates the levels in the reference point.

- Quality profile: allows to select the quality profile .
- Powering:
 - VDC: Selects the preamplifier powering.

6.1.2.- Options context menu



•Fast: ON/OFF. When the fast scan is enabled (ON), the meter will not make CBER and VBER measurements for digital channels, neither V/A measurements for analog channels. So, only power and level measurements will be shown.

- DiSEqC (only satellite band): selects the DiSEqC parameter (Sat A, Sat B, Sat C, Sat D).
- Positioner (only satellite band): makes it possible to control the DiSEqC motors used to move mobile parabolic antennas. This function is available in satellite mode and when the equipment is powering the LNB.

Halt: This command stops the motor movement.

East: Allows to move the motor in the EAST direction. Each click corresponds to one step in the movement of the motor (pitch motors). By holding the key down, successive movement sequences will be executed until the key is released.

West: Motor movement in the WEST direction. Each click corresponds to one step in the movement of the motor (pitch motors). By holding the key down, successive movement sequences will be executed until the key is released.

Store: 8 storage positions are available to store at up to 8 antenna positions. This command allows one of 8 positions to be chosen where the current position of the antenna will be stored.

Goto: recovers one of the 8 positions for the antenna that has been previously stored

- SCR (only satellite band): Selects the SCR parameters (multiswitch, standard and slots) When a slot is enabled (for example slot 3, freq. 1210MHz), the meter will tune into the slot frequency (1210MHz) and will set the slot with the meter parameters: frequency, band (powering), and DiSEqC. In addition, a SCR icon will be shown in the bar at the top (SCR3) to indicate that the slot is enabled. While the slot is enabled, all the setting changes of the meter, will be applied to the currently slot (SCR3).

6.2.- Mosaiq 3+1

This screen has 4 widgets, 3 in the top of the screen and one in the lower part of the screen. These widgets are user-configurable, that is, the user can select the function he or she wants to visualize in each widget.

6.2.1.- Main window



All the available features are explained in section 6.4.- Features.

6.2.2.- Options context menu:



- Quality profile: allows to select the quality profile
- Powering:
 - VDC: Selects the preamplifier powering.
 - DiSEqC (only satellite band): selects the DiSEqC parameter (Sat A, Sat B, Sat C, Sat D).
 - Positioner (only satellite band): makes it possible to control the DiSEqC motors used to move mobile parabolic antennas. This

function is available in satellite mode and when the equipment is powering the LNB.

Halt: This command stops the motor movement.

East: Allows to move the motor in the EAST direction. Each click corresponds to one step in the movement of the motor (pitch motors). By holding the key down, successive movement sequences will be executed until the key is released.

West: Motor movement in the WEST direction. Each click corresponds to one step in the movement of the motor (pitch motors). By holding the key down, successive movement sequences will be executed until the key is released.

Store: 8 storage positions are available to store at up to 8 antenna positions. This command allows one of 8 positions to be chosen where the current position of the antenna will be stored.

Goto: recovers one of the 8 positions for the antenna that has been previously stored.

- **SCR (only satellite band):** Selects the SCR parameters (multiswitch, standard and slots) When a slot is enabled (for example slot 3, freq. 1210MHz), the meter will tune into the slot frequency (1210MHz) and will set the slot with the meter parameters: frequency, band (powering), and DiSeqC. In addition, a SCR icon will be shown in the bar at the top (SCR3) to indicate that the slot is enabled. While the slot is enabled, all the setting changes of the meter, will be applied to the currently slot (SCR3).

6.3.- Mosaiq 6

This screen has 6 widgets. These widgets are user-configurable, that is, the user can select the function he or she wants to visualize in each widget.

6.3.1.- Main window



EN

All the available features are explained in section 6.4.- Features.

6.3.2.- Options context menu



- Quality profile: allows to select the quality profile
- Powering:
 - VDC: Selects the preamplifier powering.
 - DiSeqC (only satellite band): selects the DiSeqC parameter (Sat A, Sat B, Sat C, Sat D).

- Positioner (only satellite band): makes it possible to control the DiSEqC motors used to move mobile parabolic antennas. This function is available in satellite mode and when the equipment is powering the LNB.

Halt: This command stops the motor movement.

East: Allows to move the motor in the EAST direction. Each click corresponds to one step in the movement of the motor (pitch motors). By holding the key down, successive movement sequences will be executed until the key is released.

West: Motor movement in the WEST direction. Each click corresponds to one step in the movement of the motor (pitch motors). By holding the key down, successive movement sequences will be executed until the key is released.

Store: 8 storage positions are available to store at up to 8 antenna positions. This command allows one of 8 positions to be chosen where the current position of the antenna will be stored.

Goto: recovers one of the 8 positions for the antenna that has been previously stored

- SCR (only satellite band): Selects the SCR parameters (multiswitch, standard and slots) When a slot is enabled (for example slot 3, freq. 1210MHz), the meter will tune into the slot frequency (1210MHz) and will set the slot with the meter parameters: frequency, band (powering), and DiSEqC. In addition, a SCR icon will be shown in the bar at the top (SCR3) to indicate that the slot is enabled. While the slot is enabled, all the setting changes of the meter, will be applied to the currently slot (SCR3).

6.4.- Features



This section explains all the features available to visualize in the widgets of the Mosaiq 3+1 and Mosaiq 6 modes.

Note: If the ASI input is selected, only Television and Services features will be available.

6.4.1.- Television

This feature allows to visualize the selected service's image of the tuned channel.

Note: When the image is not available, one of these icons will be shown:

- Only audio service 
- Encrypted channel 
- Data service 

6.4.1.1.- Main window

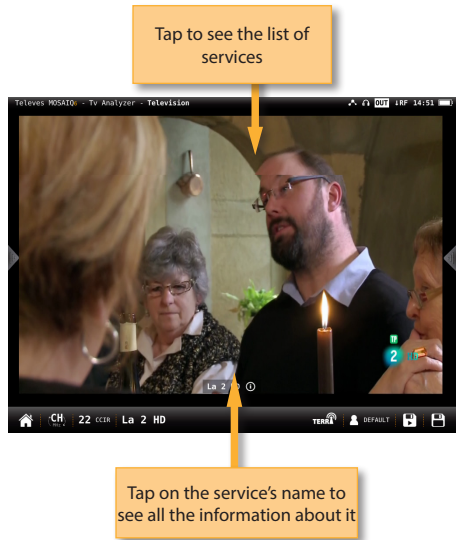

Tapping on the screen, it appears a popup window with the list of the channel's services:



Tap on the service to select it

Next to the name of the service, the icons indicating the transports are shown (image, one or more audio transports). To change the audio, tap again on the screen and select the same service in the list, then a new pop-up window will appear showing the available audios.

Tapping on the service's name, it appears a popup window with the information about it:

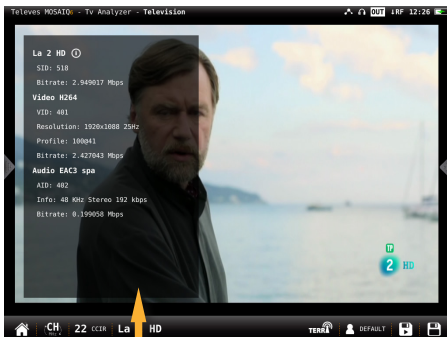

Tap to close the popup window

6.4.1.2.- Options context menu



- Quality profile: allows to select the quality profile
- Powering:

- VDC: Selects the preamplifier powering.
- DiSEqC (only satellite band): selects the DiSEqC parameter (Sat A, Sat B, Sat C, Sat D).
- Positioner (only satellite band): makes it possible to control the DiSEqC motors used to move mobile parabolic antennas. This function is available in satellite mode and when the equipment is powering the LNB.

Halt: This command stops the motor movement.

East: Allows to move the motor in the EAST direction. Each click corresponds to one step in the movement of the motor (pitch motors). By holding the key down, successive movement sequences will be executed until the key is released.

West: Motor movement in the WEST direction. Each click corresponds to one step in the movement of the motor (pitch motors). By holding the key down, successive movement sequences will be executed until the key is released.

Store: 8 storage positions are available to store at up to 8 antenna positions. This command allows one of 8 positions to be chosen where the current position of the antenna will be stored.

Goto: recovers one of the 8 positions for the antenna that has been previously stored

- SCR (only satellite band): Selects the SCR parameters (multiswitch, standard and slots) When a slot is enabled (for example slot 3, freq. 1210MHz), the meter will tune into the slot frequency (1210MHz) and will set the slot with the meter parameters: frequency, band (powering), and DiSEqC. In addition, a SCR icon will be shown in the bar at the top (SCR3) to indicate that the slot is enabled. While the slot is enabled, all the setting changes of the meter, will be applied to the currently slot (SCR3).

6.4.2.- Services

This features shows a graph with the distribution of the services as the channel. Tapping on one of the sections of the graph, you can see the name of the corresponding service. If you see this feature in full screen, you will have more detailed information.

6.4.2.1.- Main window

The screenshot shows the 'Services' menu with a pie chart on the left and a list of services on the right. Callouts provide the following information:

- Graph with the distribution of the channels services:** Points to the pie chart showing service distribution.
- List of services with ID, the LCN (for DVB channels) or the Virtual Channel (for ISDB-T channels), the service name, and bitrates. The color of the squares corresponds to the color of the section in the graph:** Points to the service list table.
- Distribution and bitrates of the service PIDs:** Points to the 'ID Stream' table.
- Service PIDs. The colors of the squares indicate the PID type:** Points to the 'ID Stream' table.

ID	Service	Rate (Mbps)
513	Clan	1.679463
514	La 1 HD	4.544436
515	PNE Galicia	0.143027
516	Radio 5 PNE	0.143027
518	La 2 HD	3.555846
	Null Packets	0.562302
Total TS (9 Services)		20.653333

ID	Stream	Bitrate (Mbps)
115	Data	0.002949
301	Video H264	4.001819
302	Audio EAC3 spa	0.269835
303	Audio EAC3 spa	0.268360
304	Audio EAC3 spa	0.072250
401	Audio EAC3 spa	0.071674
402	Audio EAC3 spa	0.071674
403	Audio EAC3 spa	0.071674
404	Audio EAC3 spa	0.071674
405	Audio EAC3 spa	0.071674
406	Audio EAC3 spa	0.071674
407	Audio EAC3 spa	0.071674
408	Audio EAC3 spa	0.071674
409	Audio EAC3 spa	0.071674
410	Audio EAC3 spa	0.071674
411	Audio EAC3 spa	0.071674
412	Audio EAC3 spa	0.071674
413	Audio EAC3 spa	0.071674
414	Audio EAC3 spa	0.071674
415	Audio EAC3 spa	0.071674
416	Audio EAC3 spa	0.071674
417	Audio EAC3 spa	0.071674
418	Audio EAC3 spa	0.071674
419	Audio EAC3 spa	0.071674
420	Audio EAC3 spa	0.071674
421	Audio EAC3 spa	0.071674
422	Audio EAC3 spa	0.071674
423	Audio EAC3 spa	0.071674
424	Audio EAC3 spa	0.071674
425	Audio EAC3 spa	0.071674
426	Audio EAC3 spa	0.071674
427	Audio EAC3 spa	0.071674
428	Audio EAC3 spa	0.071674
429	Audio EAC3 spa	0.071674
430	Audio EAC3 spa	0.071674
431	Audio EAC3 spa	0.071674
432	Audio EAC3 spa	0.071674
433	Audio EAC3 spa	0.071674
434	Audio EAC3 spa	0.071674
435	Audio EAC3 spa	0.071674
436	Audio EAC3 spa	0.071674
437	Audio EAC3 spa	0.071674
438	Audio EAC3 spa	0.071674
439	Audio EAC3 spa	0.071674
440	Audio EAC3 spa	0.071674
441	Audio EAC3 spa	0.071674
442	Audio EAC3 spa	0.071674
443	Audio EAC3 spa	0.071674
444	Audio EAC3 spa	0.071674
445	Audio EAC3 spa	0.071674
446	Audio EAC3 spa	0.071674
447	Audio EAC3 spa	0.071674
448	Audio EAC3 spa	0.071674
449	Audio EAC3 spa	0.071674
450	Audio EAC3 spa	0.071674
451	Audio EAC3 spa	0.071674
452	Audio EAC3 spa	0.071674
453	Audio EAC3 spa	0.071674
454	Audio EAC3 spa	0.071674
455	Audio EAC3 spa	0.071674
456	Audio EAC3 spa	0.071674
457	Audio EAC3 spa	0.071674
458	Audio EAC3 spa	0.071674
459	Audio EAC3 spa	0.071674
460	Audio EAC3 spa	0.071674
461	Audio EAC3 spa	0.071674
462	Audio EAC3 spa	0.071674
463	Audio EAC3 spa	0.071674
464	Audio EAC3 spa	0.071674
465	Audio EAC3 spa	0.071674
466	Audio EAC3 spa	0.071674
467	Audio EAC3 spa	0.071674
468	Audio EAC3 spa	0.071674
469	Audio EAC3 spa	0.071674
470	Audio EAC3 spa	0.071674
471	Audio EAC3 spa	0.071674
472	Audio EAC3 spa	0.071674
473	Audio EAC3 spa	0.071674
474	Audio EAC3 spa	0.071674
475	Audio EAC3 spa	0.071674
476	Audio EAC3 spa	0.071674
477	Audio EAC3 spa	0.071674
478	Audio EAC3 spa	0.071674
479	Audio EAC3 spa	0.071674
480	Audio EAC3 spa	0.071674
481	Audio EAC3 spa	0.071674
482	Audio EAC3 spa	0.071674
483	Audio EAC3 spa	0.071674
484	Audio EAC3 spa	0.071674
485	Audio EAC3 spa	0.071674
486	Audio EAC3 spa	0.071674
487	Audio EAC3 spa	0.071674
488	Audio EAC3 spa	0.071674
489	Audio EAC3 spa	0.071674
490	Audio EAC3 spa	0.071674
491	Audio EAC3 spa	0.071674
492	Audio EAC3 spa	0.071674
493	Audio EAC3 spa	0.071674
494	Audio EAC3 spa	0.071674
495	Audio EAC3 spa	0.071674
496	Audio EAC3 spa	0.071674
497	Audio EAC3 spa	0.071674
498	Audio EAC3 spa	0.071674
499	Audio EAC3 spa	0.071674
500	Audio EAC3 spa	0.071674
501	Audio EAC3 spa	0.071674
502	Audio EAC3 spa	0.071674
503	Audio EAC3 spa	0.071674
504	Audio EAC3 spa	0.071674
505	Audio EAC3 spa	0.071674
506	Audio EAC3 spa	0.071674
507	Audio EAC3 spa	0.071674
508	Audio EAC3 spa	0.071674
509	Audio EAC3 spa	0.071674
510	Audio EAC3 spa	0.071674
511	Audio EAC3 spa	0.071674
512	Audio EAC3 spa	0.071674
513	Audio EAC3 spa	0.071674
514	Audio EAC3 spa	0.071674
515	Audio EAC3 spa	0.071674
516	Audio EAC3 spa	0.071674
517	Audio EAC3 spa	0.071674
518	Audio EAC3 spa	0.071674
519	Audio EAC3 spa	0.071674
520	Audio EAC3 spa	0.071674
521	Audio EAC3 spa	0.071674
522	Audio EAC3 spa	0.071674
523	Audio EAC3 spa	0.071674
524	Audio EAC3 spa	0.071674
525	Audio EAC3 spa	0.071674
526	Audio EAC3 spa	0.071674
527	Audio EAC3 spa	0.071674
528	Audio EAC3 spa	0.071674
529	Audio EAC3 spa	0.071674
530	Audio EAC3 spa	0.071674
531	Audio EAC3 spa	0.071674
532	Audio EAC3 spa	0.071674
533	Audio EAC3 spa	0.071674
534	Audio EAC3 spa	0.071674
535	Audio EAC3 spa	0.071674
536	Audio EAC3 spa	0.071674
537	Audio EAC3 spa	0.071674
538	Audio EAC3 spa	0.071674
539	Audio EAC3 spa	0.071674
540	Audio EAC3 spa	0.071674
541	Audio EAC3 spa	0.071674
542	Audio EAC3 spa	0.071674
543	Audio EAC3 spa	0.071674
544	Audio EAC3 spa	0.071674
545	Audio EAC3 spa	0.071674
546	Audio EAC3 spa	0.071674
547	Audio EAC3 spa	0.071674
548	Audio EAC3 spa	0.071674
549	Audio EAC3 spa	0.071674
550	Audio EAC3 spa	0.071674
551	Audio EAC3 spa	0.071674
552	Audio EAC3 spa	0.071674
553	Audio EAC3 spa	0.071674
554	Audio EAC3 spa	0.071674
555	Audio EAC3 spa	0.071674
556	Audio EAC3 spa	0.071674
557	Audio EAC3 spa	0.071674
558	Audio EAC3 spa	0.071674
559	Audio EAC3 spa	0.071674
560	Audio EAC3 spa	0.071674
561	Audio EAC3 spa	0.071674
562	Audio EAC3 spa	0.071674
563	Audio EAC3 spa	0.071674
564	Audio EAC3 spa	0.071674
565	Audio EAC3 spa	0.071674
566	Audio EAC3 spa	0.071674
567	Audio EAC3 spa	0.071674
568	Audio EAC3 spa	0.071674
569	Audio EAC3 spa	0.071674
570	Audio EAC3 spa	0.071674
571	Audio EAC3 spa	0.071674
572	Audio EAC3 spa	0.071674
573	Audio EAC3 spa	0.071674
574	Audio EAC3 spa	0.071674
575	Audio EAC3 spa	0.071674
576	Audio EAC3 spa	0.071674
577	Audio EAC3 spa	0.071674
578	Audio EAC3 spa	0.071674
579	Audio EAC3 spa	0.071674
580	Audio EAC3 spa	0.071674
581	Audio EAC3 spa	0.071674
582	Audio EAC3 spa	0.071674
583	Audio EAC3 spa	0.071674
584	Audio EAC3 spa	0.071674
585	Audio EAC3 spa	0.071674
586	Audio EAC3 spa	0.071674
587	Audio EAC3 spa	0.071674
588	Audio EAC3 spa	0.071674
589	Audio EAC3 spa	0.071674
590	Audio EAC3 spa	0.071674
591	Audio EAC3 spa	0.071674
592	Audio EAC3 spa	0.071674
593	Audio EAC3 spa	0.071674
594	Audio EAC3 spa	0.071674
595	Audio EAC3 spa	0.071674
596	Audio EAC3 spa	0.071674
597	Audio EAC3 spa	0.071674
598	Audio EAC3 spa	0.071674
599	Audio EAC3 spa	0.071674
600	Audio EAC3 spa	0.071674
601	Audio EAC3 spa	0.071674
602	Audio EAC3 spa	0.071674
603	Audio EAC3 spa	0.071674
604	Audio EAC3 spa	0.071674
605	Audio EAC3 spa	0.071674
606	Audio EAC3 spa	0.071674
607	Audio EAC3 spa	0.071674
608	Audio EAC3 spa	0.071674
609	Audio EAC3 spa	0.071674
610	Audio EAC3 spa	0.071674
611	Audio EAC3 spa	0.071674
612	Audio EAC3 spa	0.071674
613	Audio EAC3 spa	0.071674
614	Audio EAC3 spa	0.071674
615	Audio EAC3 spa	0.071674
616	Audio EAC3 spa	0.071674
617	Audio EAC3 spa	0.071674
618	Audio EAC3 spa	0.071674
619	Audio EAC3 spa	0.071674
620	Audio EAC3 spa	0.071674
621	Audio EAC3 spa	0.071674
622	Audio EAC3 spa	0.071674
623	Audio EAC3 spa	0.071674
624	Audio EAC3 spa	0.071674
625	Audio EAC3 spa	0.071674
626	Audio EAC3 spa	0.071674
627	Audio EAC3 spa	0.071674
628	Audio EAC3 spa	0.071674
629	Audio EAC3 spa	0.071674
630	Audio EAC3 spa	0.071674
631	Audio EAC3 spa	0.071674
632	Audio EAC3 spa	0.071674
633	Audio EAC3 spa	0.071674
634	Audio EAC3 spa	0.071674
635	Audio EAC3 spa	0.071674
636	Audio EAC3 spa	0.071674
637	Audio EAC3 spa	0.071674
638	Audio EAC3 spa	0.071674
639	Audio EAC3 spa	0.071674
640	Audio EAC3 spa	0.071674
641	Audio EAC3 spa	0.071674
642	Audio EAC3 spa	0.071674
643	Audio EAC3 spa	0.071674
644	Audio EAC3 spa	0.071674
645	Audio EAC3 spa	0.071674
646	Audio EAC3 spa	0.071674
647	Audio EAC3 spa	0.071674
648	Audio EAC3 spa	0.071674
649	Audio EAC3 spa	0.071674
650	Audio EAC3 spa	0.071674
651	Audio EAC3 spa	0.071674
652	Audio EAC3 spa	0.071674
653	Audio EAC3 spa	0.071674
654	Audio EAC3 spa	0.071674
655	Audio EAC3 spa	0.071674
656	Audio EAC3 spa	0.071674
657	Audio EAC3 spa	0.071674
658	Audio EAC3 spa	0.071674
659	Audio EAC3 spa	0.071674
660	Audio EAC3 spa	0.071674
661	Audio EAC3 spa	0.071674
662	Audio EAC3 spa	0.071674
663	Audio EAC3 spa	0.071674
664	Audio EAC3 spa	0.071674
665	Audio EAC3 spa	0.071674
666	Audio EAC3 spa	0.071674
667	Audio EAC3 spa	0.071674
668	Audio EAC3 spa	0.071674
669	Audio EAC3 spa	0.071674
670	Audio EAC3 spa	0.071674
671	Audio EAC3 spa	0.071674
672	Audio EAC3 spa	0.071674
673	Audio EAC3 spa	0.071674
674	Audio EAC3 spa	0.071674
675	Audio EAC3 spa	0.071674
676	Audio EAC3 spa	0.071674
677	Audio EAC3 spa	0.071674
678	Audio EAC3 spa	0.071674
679	Audio EAC3 spa	0.071674
680	Audio EAC3 spa	0.071674
681	Audio EAC3 spa	0.071674
682	Audio EAC3 spa	0.071674
683	Audio EAC3 spa	0.071674
684	Audio EAC3 spa	0.071674
685	Audio EAC3 spa	0.071674
686	Audio EAC3 spa	0.071674
687	Audio EAC3 spa	0.071674
688	Audio EAC3 spa	0.071674
689	Audio EAC3 spa	0.071674
690	Audio EAC3 spa	0.071674
691	Audio EAC3 spa	0.071674
692	Audio EAC3 spa	0.071674
693	Audio EAC3 spa	0.071674
694	Audio EAC3 spa	0.071674
695	Audio EAC3 spa	0.071674
696	Audio EAC3 spa	0.071674
697	Audio EAC3 spa	0.071674
698	Audio EAC3 spa	0.071674
699	Audio EAC3 spa	0.071674
700	Audio EAC3 spa	0.071674
701	Audio EAC3 spa	0.071674
702	Audio EAC3 spa	0.071674
703	Audio EAC3 spa	0.071674
704	Audio EAC3 spa	0.071674
705	Audio EAC3 spa	0.071674
706	Audio EAC3 spa	0.071674
707	Audio EAC3 spa	0.071674
708	Audio EAC3 spa	0.071674
709	Audio EAC3 spa	0.071674
710	Audio EAC3 spa	0.071674
711	Audio EAC3	

When a slot is enabled (for example slot 3, freq. 1210MHz), the meter will tune into the slot frequency (1210MHz) and will set the slot with the meter parameters: frequency, band (powering), and DiSeqC. In addition, a SCR icon will be shown in the bar at the top (SCR3) to indicate that the slot is enabled. While the slot is enabled, all the setting changes of the meter, will be applied to the currently slot (SCR3).

6.4.3.- Measurements

This feature shows the measurements of the selected channel. The measurements depends on the signal modulation:

- DVB-S: Power, C/N, MER, CBER, VBER
- DVB-S2: Power, C/N, MER, LDPCBER, BCHBER
- DVB-T: Power, C/N, MER, CBER, VBER
- DVB-T2: Power, C/N, Link Margin, LDPCBER, BCHBER
- DVB-C: Power, C/N, CBER, MER
- Analog: Level, C/N, V/A, HUM, CTB, CSO

If you see this feature in full screen, you will have more detailed information.

6.4.3.1.- Main window

The screenshot shows the 'Measures' window with the following data:

Measurement	Value	Unit
Power	57.8	dBμV
C/N	36.6	dB
MER	32.5	dB
CBER	2.4E-6	
VBER	<1.0E-8	

Parameter	Value
Standard	DVB-T
BW	Auto(8.0MHz)
Constellation	64QAM
N. Carriers	8K
Guard Interval	1/4
Code Rate	2/3
Offset	0
Cell ID	0x0

6.4.3.2.- Options context menu

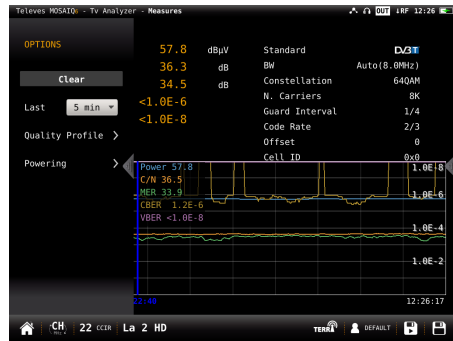

- Clear: restarts the graph.
- Last: 5 min, ½ hour, ½ day, 1 day, 1 week. Allows select the time interval shown in the graph
- Quality profile: allows to select the quality profile
- Powering:
 - VDC: Selects the preamplifier powering.
 - DiSeqC (only satellite band): selects the DiSeqC parameter (Sat A, Sat B, Sat C, Sat D).
 - Positioner (only satellite band): makes it possible to control the DiSeqC motors used to move mobile parabolic antennas. This function is available in satellite mode and when the equipment is powering the LNB.

Halt: This command stops the motor movement.

East: Allows to move the motor in the EAST direction. Each click corresponds to one step in the movement of the motor (pitch motors). By holding the key down, successive movement sequences will be executed until the key is released.

West: Motor movement in the WEST direction. Each click corresponds to one step in the movement of the motor (pitch motors). By holding the key down, successive movement sequences will be executed until the key is released.

Store: 8 storage positions are available to store at up to 8 antenna positions . This command allows one of 8 positions to be

chosen where the current position of the antenna will be stored.

Goto: recovers one of the 8 positions for the antenna that has been previously stored

- SCR (only satellite band): Selects the SCR parameters (multiswitch, standard and slots) When a slot is enabled (for example slot 3, freq. 1210MHz), the meter will tune into the slot frequency (1210MHz) and will set the slot with the meter parameters: frequency, band (powering), and DiSEqC. In addition, a SCR icon will be shown in the bar at the top (SCR3) to indicate that the slot is enabled. While the slot is enabled, all the setting changes of the meter, will be applied to the currently slot (SCR3).
- CTB (only analog channels): Turns ON/OFF the CTB measurement. If you select CTB ON, a popup window will be displayed asking you to turn the signal off. CTB can only be made with the service disabled, because it is a measurement made in the frequency of the video carrier of the TV signal. Turn the signal ON again to measure CTB and all other measurements properly.
- CSO Offsets (only analog channels): The CSO measure is carried out in different frequencies (at different distances from the video carrier) within the selected channel. Using this menu you can select the offset where you want to measure the CSO, and you can save up to 6 offset values, that can be the default values or user-selected ones.

6.4.4.- Spectrum

This feature shows the spectrum of the signal.

6.4.4.1.-Main window

Swipe to tune next/previous channel
Drag to tune any channel
Spread/Pinch to change span

Spectrum parameters

Power or C/N measurement. Tap to change

Tap to enable/disable marks

The screenshot shows a spectrum plot with a yellow signal trace. The y-axis is labeled '50A' and ranges from -10 to 30. The x-axis shows frequencies: 472.000MHz, 482.000MHz, and 492.000MHz. A 'Power' measurement is shown at the bottom left as '57.8 dBµV'. The top right corner displays 'SPAN: 20MHz', 'BW: 9MHz', 'RBW: 180kHz', and 'VBW: 3kHz'. The bottom status bar shows 'CH 2', 'SCR3', 'TEST', 'DEFAULT', and a save icon.

If you tap to enable marks:

Drag to move the active mark

Tap to activate a mark + adds a new mark (max. 4). - removes the active mark

Delta: measures the level difference between two marks

The screenshot shows the same spectrum plot as above but with several vertical red marks. A blue line connects two marks, and a 'Delta' measurement is shown at the bottom right as '-7.0 MHz' and '+27.2 dB'. The bottom status bar now shows 'C/N 36.9 dB' and a list of marks: '482.07 MHz 34.1 dBµV', '482.07 MHz 34.1 dBµV', '488.920 MHz 26.8 dBµV', and '492.000MHz'. The top right corner shows 'SPAN: 20MHz', 'BW: 9MHz', 'RBW: 180kHz', and 'VBW: 3kHz'. The bottom status bar also shows 'MARKS' and a list of marks.

6.4.4.2.- Options context menu



- Span: 100KHz, 1MHz, 5MHz, 10 MHz, 20 MHz, 50 MHz, 100 MHz, 200 MHz, 500 MHz, 1.0GHz, 2.0GHz, 3.3GHz, Other.
- Reference level: Auto, 50dB μ V – 130dB μ V
- RBW: 500 HzW – 5MHzW
- VBW: 100Hz – 1MHz
- Advanced: Access to spectrum advanced features:
 - Hold: enables/disables max. hold & min. hold features. Tapping on Clear button to restart hold trace.
 - Trigger: enables/disables the trigger by level feature. To select the level, tap on the label and a popup keyboard appears.
 - Fill: enables/disables the spectrum graph filled.
- Quality profile: allows to select the quality profile
- Powering:
 - VDC: Selects the preamplifier powering.
 - DiSEqC (only satellite band): selects the DiSEqC parameter (Sat A, Sat B, Sat C, Sat D).
 - Positioner (only satellite band): makes it possible to control the DiSEqC motors used to move mobile parabolic antennas. This function is available in satellite mode and when the equipment is powering the LNB.
 - Halt: This command stops the motor movement.
 - East: Allows to move the motor in the EAST direction. Each click corresponds to

one step in the movement of the motor (pitch motors). By holding the key down, successive movement sequences will be executed until the key is released.

West: Motor movement in the WEST direction. Each click corresponds to one step in the movement of the motor (pitch motors). By holding the key down, successive movement sequences will be executed until the key is released.

Store: 8 storage positions are available to store at up to 8 antenna positions . This command allows one of 8 positions to be chosen where the current position of the antenna will be stored.

Goto: recovers one of the 8 positions for the antenna that has been previously stored

- SCR (only satellite band): Selects the SCR parameters (multiswitch, standard and slots) When a slot is enabled (for example slot 3, freq. 1210MHz), the meter will tune into the slot frequency (1210MHz) and will set the slot with the meter parameters: frequency, band (powering), and DiSEqC. In addition, a SCR icon will be shown in the bar at the top (SCR3) to indicate that the slot is enabled. While the slot is enabled, all the setting changes of the meter, will be applied to the currently slot (SCR3).

6.4.5.- Constellation

This feature shows the constellation diagram of the tuned channel.

6.4.5.1.- Main window

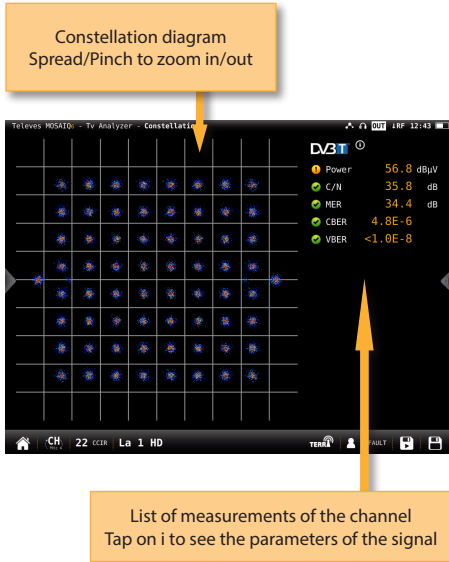

DVB-T), Other. Allows you to select the constellation of the selected carrier(s).

- Quality profile: allows to select the quality profile
- Powering:
 - VDC: Selects the preamplifier powering.
 - DiSeqC (only satellite band): selects the DiSeqC parameter (Sat A, Sat B, Sat C, Sat D).
 - Positioner (only satellite band): makes it possible to control the DiSeqC motors used to move mobile parabolic antennas. This function is available in satellite mode and when the equipment is powering the LNB.
 - Halt: This command stops the motor movement.

East: Allows to move the motor in the EAST direction. Each click corresponds to one step in the movement of the motor (pitch motors). By holding the key down, successive movement sequences will be executed until the key is released.

West: Motor movement in the WEST direction. Each click corresponds to one step in the movement of the motor (pitch motors). By holding the key down, successive movement sequences will be executed until the key is released.

Store: 8 storage positions are available to store at up to 8 antenna positions . This command allows one of 8 positions to be chosen where the current position of the antenna will be stored.

Goto: recovers one of the 8 positions for the antenna that has been previously stored

-SCR (only satellite band): Selects the SCR parameters (multiswitch, standard and slots) When a slot is enabled (for example slot 3, freq. 1210MHz), the meter will tune into the slot frequency (1210MHz) and will set the slot with the meter parameters: frequency, band (powering), and DiSeqC. In addition, a SCR icon will be shown in the bar at the top (SCR3) to indicate that the slot is enabled. While the slot is enabled, all the setting changes of the meter, will be applied to the currently slot (SCR3).

6.4.1.2.- Options context menu

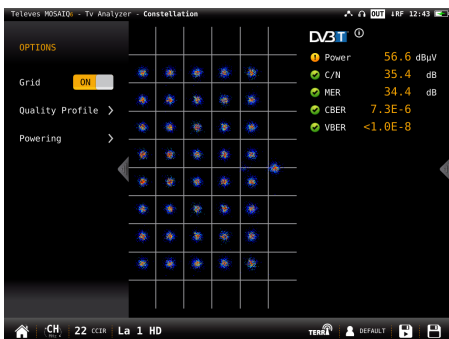

- Grid: ON/OFF. Shows/hide the grid.
- Carrier (only DVB-T/T2): All, TPS+continual (only

6.4.6.- Echoes

This feature you allows to visualize the echoes of the received signal, helping the installer to minimize

them as much as possible for optimal signal reception.

6.4.6.1.- Main window



6.4.6.2.- Options context menu:



•Min. Level: allows to indicate the level from which the meter must take account of the echoes. You can also change this level by dragging the horizontal orange level.

•Zoom: OFF, 2x, 4x, 8x, 16x. You can also Spread/pinch on the screen.

•Units: us, Km.

•Quality profile: allows to select the quality profile

•Powering:

- VDC: Selects the preamplifier powering.
 - DiSEqC (only satellite band): selects the DiSEqC parameter (Sat A, Sat B, Sat C, Sat D).
 - Positioner (only satellite band): makes it possible to control the DiSEqC motors used to move mobile parabolic antennas. This function is available in satellite mode and when the equipment is powering the LNB.
- Halt: This command stops the motor movement.

East: Allows to move the motor in the EAST direction. Each click corresponds to one step in the movement of the motor (pitch motors). By holding the key down, successive movement sequences will be executed until the key is released.

West: Motor movement in the WEST direction. Each click corresponds to one step in the movement of the motor (pitch motors). By holding the key down, successive movement sequences will be executed until the key is released.

Store: 8 storage positions are available to store at up to 8 antenna positions . This command allows one of 8 positions to be chosen where the current position of the antenna will be stored.

Goto: recovers one of the 8 positions for the antenna that has been previously stored

- SCR (only satellite band): Selects the SCR parameters (multiswitch, standard and slots) When a slot is enabled (for example slot 3, freq. 1210MHz), the meter will tune into the slot frequency (1210MHz) and will set the slot with the meter parameters: frequency, band (powering), and DiSEqC. In addition, a SCR icon will be shown in the bar at the top (SCR3) to indicate that the slot is enabled. While the slot is enabled, all the setting changes of the meter, will be applied to the currently slot (SCR3).

6.4.7.- MER/carrier

This feature represents MER value for each carrier of the DVB-T signal. This is pretty useful to detect

if there is any interference inside the channel that makes the quality signal to get worse and that is invisible for a traditional spectral analysis.

6.4.7.1.- Main window

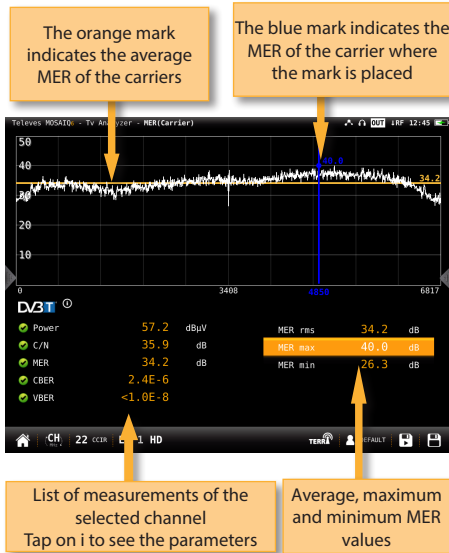

- MER RMS: Average MER of the DVB-T signal.
- MER max: Maximum MER value of the DVB-T signal. In parentheses the number of carrier with this maximum value of MER. If you tap on this measurement, the blue mark will move to the carrier with the maximum MER, and will be moving searching the carrier with maximum MER each time.
- MER min: Minimum MER value of the DVB-T signal. In parentheses the number of carrier with this minimum value of MER. If you tap on this measurement, the blue mark will move to the carrier with the minimum MER, and will be moving searching the carrier with minimum MER each time.

6.4.7.2.- Options context menu

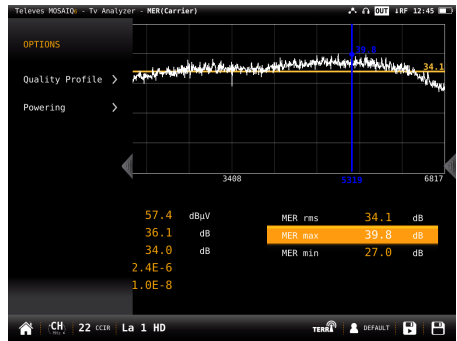

- Carrier: allows you to select the carrier where you want to measure the MER, placing the blue marker on the graph.
- Quality profile: allows to select the quality profile
- Powering:
 - VDC: Selects the preamplifier powering.

6.4.8.- Uncorrected packets

This feature makes an uncorrected packet analysis during a timer interval selected by the user.

6.4.8.1.- Main window

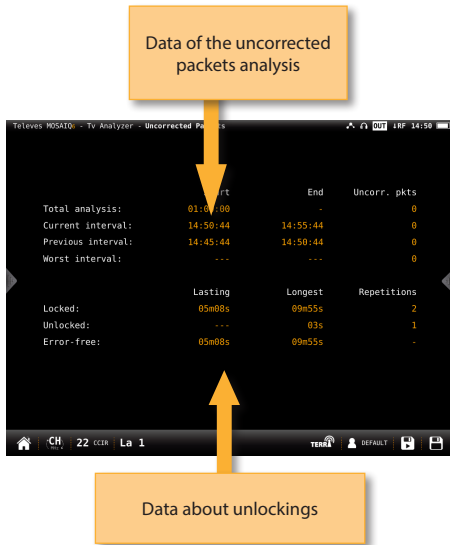

6.4.8.2.- Options context menu:



- Restart: restart the uncorrected packets analysis
- Interval: Change the analysis interval time. The interval is configurable between 1 minute and 1 hour.

- Powering:
 - VDC: Selects the preamplifier powering.
 - DiSEqC (only satellite band): selects the DiSEqC parameter (Sat A, Sat B, Sat C, Sat D).
 - Positioner (only satellite band): makes it possible to control the DiSEqC motors used to move mobile parabolic antennas. This function is available in satellite mode and when the equipment is powering the LNB.

Halt: This command stops the motor movement.

East: Allows to move the motor in the EAST direction. Each click corresponds to one step in the movement of the motor (pitch motors). By holding the key down, successive movement sequences will be executed until the key is released.

West: Motor movement in the WEST direction. Each click corresponds to one step in the movement of the motor (pitch motors). By holding the key down, successive movement sequences will be executed until the key is released.

Store: 8 storage positions are available to store at up to 8 antenna positions. This command allows one of 8 positions to be chosen where the current position of the antenna will be stored.

Total analysis: Start and end time of the analysis, and number of uncorrected packets in all the intervals analysed.

Current interval: Start and end time of the current interval, and number of uncorrected packets.

Previous interval: Start and end time of the previous interval and number of uncorrected packets.

Worst interval: Start and end time of the interval with more uncorrected packets, and number of uncorrected packets in the worst interval of analysis since it was started.

Locked: Time gone by since the demodulator locked to the digital signal the last time, longest time the digital signal was locked, and number of locking.

Unlocked: Time gone by since the demodulator unlocked to the digital signal the last time, longest time the digital signal was unlocked, and number of unlocking.

Error-free: Time gone by since last uncorrected packet, and longest time gone by since last uncorrected packet.

Goto: recovers one of the 8 positions for the antenna that has been previously stored

- SCR (only satellite band): Selects the SCR parameters (multiswitch, standard and slots) When a slot is enabled (for example slot 3, freq. 1210MHz), the meter will tune into the slot frequency (1210MHz) and will set the slot with the meter parameters: frequency, band (powering), and DiSEqC. In addition, a SCR icon will be shown in the bar at the top (SCR3) to indicate that the slot is enabled. While the slot is enabled, all the setting changes of the meter, will be applied to the currently slot (SCR3).



7. Spectrum analyser

These feature has two screens: spectrum analyser and waterfall. Long swipe to switch between them.

7.1.- Spectrum analyser

This feature shows the spectrum of the input signal.

7.1.1.- Main window

Swipe to tune next/previous channel
Drag to tune any channel
Spread/Pinch to change span

Spectrum parameters

Power or C/N measurement.
Tap to change

Tap to enable/disable the marks

Televés MOSAIO - Tv Analyzer - Spectrum

50A

30

10

-10

SPAN: 20MHz
BW: 6MHz
RBW: 180kHz
VBW: 30Hz

472.000MHz 482.000MHz 492.000MHz

Power 57.8 dBµV

MARKS

CH 2 CCIR TERRA DEFAULT

If you tap to enable the marks:



•VBW: 100Hz – 1MHz

•Advanced: Access to spectrum advanced features:

- Hold: enables/disables max. hold & min. hold features. Tapping on Clear button to restart hold trace.
- Trigger: enables/disables the trigger by level feature. To select the level, tap on the label and a popup keyboard appears.
- Fill: enables/disables the spectrum graph filled.

•Quality profile: allows to select the quality profile

•Powering:

- VDC: Selects the preamplifier powering.
- DiSeqC (only satellite band): selects the DiSeqC parameter (Sat A, Sat B, Sat C, Sat D).
- Positioner (only satellite band): makes it possible to control the DiSeqC motors used to move mobile parabolic antennas. This function is available in satellite mode and when the equipment is powering the LNB.

Halt: This command stops the motor movement.

East: Allows to move the motor in the EAST direction. Each click corresponds to one step in the movement of the motor (pitch motors). By holding the key down, successive movement sequences will be executed until the key is released.

West: Motor movement in the WEST direction. Each click corresponds to one step in the movement of the motor (pitch motors). By holding the key down, successive movement sequences will be executed until the key is released.

Store: 8 storage positions are available to store at up to 8 antenna positions. This command allows one of 8 positions to be chosen where the current position of the antenna will be stored.

Goto: recovers one of the 8 positions for the antenna that has been previously stored

- SCR (only satellite band): Selects the SCR parameters (multiswitch, standard and slots) When a slot is enabled (for example slot 3, freq. 1210MHz), the meter will tune into the slot frequency (1210MHz) and will set the slot with the meter parameters:

7.1.2.- Options context menu



•Span: 100KHz, 1MHz, 5MHz, 10 MHz, 20 MHz, 50 MHz, 100 MHz, 200 MHz, 500 MHz, 1.0GHz, 2.0GHz, 3.3GHz, Other.

•Reference level: Auto, 50dBuV – 130dBuV

•RBW: 500 HzW – 5MHzW

frequency, band (powering), and DiSeqC. In addition, a SCR icon will be shown in the bar at the top (SCR3) to indicate that the slot is enabled. While the slot is enabled, all the setting changes of the meter, will be applied to the currently slot (SCR3).

7.2.- Waterfall

The waterfall diagram is a three-dimensional representation of the signal spectrum. Signal levels are converted to colours and displayed along a time axis.

7.2.1.- Main window

Swipe to tune next/previous channel
Drag to tune any channel
Spread/Pinch to change span

Spectrum parameters

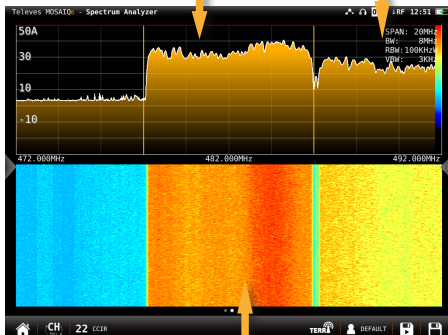

Waterfall time axis is the vertical one and frequency axis is the horizontal one, while level is converted to colour through the colour scale in the top right side

Every spectrum trace in the top half generates a new waterfall line in the bottom half.

7.2.2.- Options context menu:

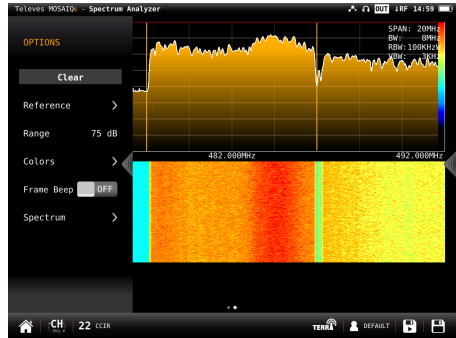

- Clear: It clears the waterfall display.
- Reference: it changes the level of the highest colour in the colour scale. Signal levels above this reference will be displayed in this colour.
- Range: it changes difference in dB between the highest and the lowest colour of the colour scale on the waterfall display.
- Colours: it changes the colour palette. Different colour combinations can be selected for the waterfall representation (Jet, Hot and BlueHot).
- Frame beep: when this option is ON, a beep sounds each time the waterfall screen fully refreshes, so there is no need to look at the screen continuously. Looking at the screen just when the beep sounds guarantees not missing any waterfall information.
- Spectrum: accesses to the spectrum options context menu (see section 7.1.- *Spectrum analyser*).



8. Radio Analyser

This feature is similar to TV Analysis in the radio band. So it has two screens: scan and mosaiq 3+1. Long swipe to switch between them.

8.1.- Scan Radio

This features scans the FM and DAB band.

The scan measurement leverages the location based thresholds to clearly show whether or not signal levels comply with the cable system's specifications with their green, yellow and red bar.

8.3.1.- Main window

Bar graph representing all the found channels

Band. Tap to change

Tap to access to the options menu

Signal spectrum

List of channels and measurements

CH	Freq(MHz)	Type	Level (dBuV)	C/N (dB)
01	87.600	FM	19.8	10.5
02	88.400	FM	22.0	12.7
03	88.900	FM	33.1	23.6
04	90.200	FM	29.6	20.8
05	90.600	FM	32.0	23.7

Tapping on icon a popup window will appear:

Selected channel
Change tapping on the bar graph or on the channel table

Table with found channels
Scroll to see them all

Options buttons

Bar graph with the channels found in the last scan

CH	Freq(MHz)	Type	Level (dBuV)	C/N (dB)
01	87.600	FM	24.3	14.8
02	88.400	FM		
03	88.900	FM		
04	90.200	FM		
05	90.600	FM		
06	92.700	FM		
07	93.000	FM		
08	97.100	FM		
09	97.600	FM		
10	98.100	FM		
11	98.600	FM		
12	99.000	FM		
13	100.200	FM		
14	101.500	FM		

EN

•Start: Starts a new system scan

•Options:

- Fast: ON/OFF. When the fast scan is enabled (ON), the meter will not make CBER and MER measurements for DAB channels. So, only power and C/N measurements will be shown.
- Wide outlet: ON/OFF. Enable this option when the outlet in your installation has both terrestrial and satellite bands. So, both bands will be scanned consecutively. If this options is disabled, only the selected band will be scanned.

Note: Note that if the selected user profile does not allow to make measurements in some bands, the scan will not be done in that band.

•Edit: Allows to add/delete channels from the plan. If the channel is selected (orange coloured), when you tap on it, it will be deselected. Otherwise, if the channel is unselected (grey coloured), when you tap on it, it will be selected.

•Save: Saves a new plan with the found channels.

- Cancel: Closes the options window

8.3.2.- Options context menu



•Fast: ON/OFF. When the fast scan is enabled (ON), the meter will not make CBER and MER measurements for DAB channels. So, only power and C/N measurements will be shown.

•Wide outlet: ON/OFF. Enable this option when the outlet in your installation has both terrestrial and satellite bands. So, both bands will be scanned consecutively. If this options is disabled, only the selected band will be scanned.

Note: Note that if the selected user profile does not allow to make measurements in some bands, the scan will not be done in that band.

•Show all: ON/OFF. When show all is ON, all the measurements of all the channels are shown. When it is OFF, you can only see the measurements of the channel that is being measured in that moment.

•Span full: ON/OFF. When Span full ins ON you can see all the bars corresponding to all the found channels. When this option is OFF, only 24 bars are shown, so it is necessary to scroll to see them all.

•Tilt: ON/OFF. When the tilt option is ON, this function measures the tilt between the channels indicated in the labels CH A and CH B. Then you can see a white line between these two channels and the tilt measurement on it.

•Attenuation: ON/OFF. When the attenuation option is ON, the MOSAIQ6 measures the

attenuation of the installation relative to a reference point, usually the head-end output. So, the first thing you must do is connect the meter to the reference point and tap on the Calibrate button. In this way, the equipment will measure and save the level of all the channels.

Then you must go to all the pints of the installation where we want to measure and connect the meter, taking care to have this function ON. The MOSAIQ6 will measure the levels of all the channels comparing them with the reference ones.

When this option is ON, the bars of the graphic don't represent the level or the power of the channels, but the attenuation of each one of them. The list shows power (or level) and C/N. In addition, a green trace is shown in the spectrum. This trace indicates the levels in the reference point.

•Quality profile: allows to select the quality profile .

•Powering:

- VDC: Selects the preamplifier powering.

8.2.- Mosaic 3+1

This screen has 4 widgets, 3 in the top of the screen and one in the lower part of the screen. These widgets are user-configurable, that is, the user can select the function he or she wants to visualize in each widget.

8.2.1.- Main Window

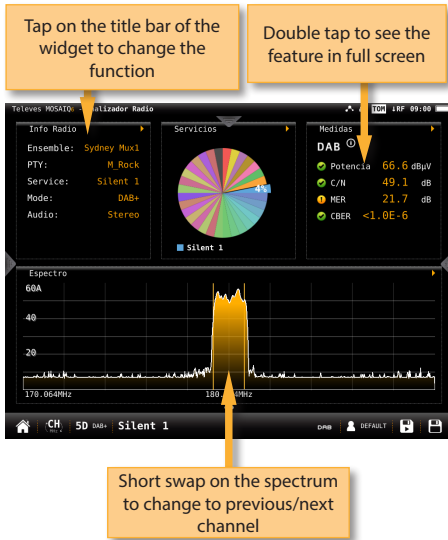

The available features are explained in section 8.3.- Radio features.

8.2.2.- Options context menu

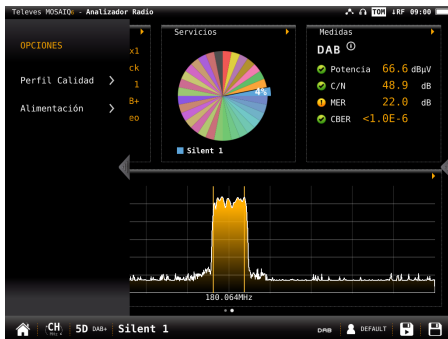

- Quality profile: allows to select the quality profile .
- Powering:
 - VDC: Selects the preamplifier powering.

8.3.- Radio features

This section explains all the features available to visualize in the widgets of the Mosaik 3+1 mode.

8.3.1.- Info radio

This feature shows the information of the tuned channel.

If it is a FM channel, the information shown is: RDS, PS name, PTY, PI, TP & radio text.

If it is a DAB channel, the information shown is: Ensemble, PTY, Service, Mode, Audio.

8.3.1.1.- Main Window



8.3.1.2.- Options context menu



- Quality profile: allows to select the quality profile .
- Powering:
 - VDC: Selects the preamplifier powering.

8.3.2.- Services (only for DAB channels)

This feature shows a graph representing the services distribution. Tapping on a section, you can see the name of the corresponding service.

8.3.2.1.- Main Window

Graph with the distribution of the channel services

List of services with IDs and bitrates. The colour of each square corresponds to the colour of the graph section

Distribution of the service's PIDs and bitrates

Service's PIDs. The colors indicate the type of PID

8.3.2.2.- Options context menu

- Quality profile: allows to select the quality profile .
- Powering:
 - VDC: Selects the preamplifier powering.

8.3.3.- Measurements

This feature shows the measurements of the selected channel. The measurements depends on the type of channel:

FM: Level, C/N

DAB: Power, C/N, BER and MER

8.3.3.1.- Main window

List of measurements of the channel

List of signal parameters

History of the measurements during an interval selected by the user. Drag to move the blue mark

8.3.3.2.- Options context menu

- Clear: restarts the graph.
- Last: 5 min, ½ hour, ½ day, 1 day, 1 week. Allows

- select the time interval shown in the graph
- Quality profile: allows to select the quality profile
- Powering:
 - VDC: Selects the preamplifier powering.



9. Wi-Fi Analyser

The **MOSAIQ6** is able to perform a full analysis of the Wi-Fi band in both 2,4GHz, and 5GHz bands. To change the band selection, tap on the corresponding icon placed in the bottom bar. When you access to this feature, the **MOSAIQ6** activates the Wi-Fi automatically and, if it has been connected to an available Wi-Fi network before, the **MOSAIQ6** has saved the password, so it will connect to the same network again automatically. The default selected Wi-Fi network is the first in the Wi-Fi list, in addition, this Wi-Fi is highlighted in the channel map of the widget in the bottom of the screen. The selected Wi-Fi does not have to match the Wi-Fi the MOSAIQ6 is connected to. The screen corresponding to this feature is Mosaiq3+1 type. This configuration has 4 widgets, 3 square ones in the top and a rectangular in the bottom. The top widgets are user-configurable.

10.1.- Main window

Tap on the top bar to select the widget feature

Double-tap to see the feature screen in full screen

The rectangular widget shows the channel map feature

9.2.- Features

This section explains all the features available to visualize in Wi-Fi analyser function.

9.2.1- Wi-Fi List

This feature shows a list with all the Wi-Fi networks detected by the **MOSAIQ6**.

In this list, the user can select the Wi-Fi network whose measurements he wants to view by tapping on it.

Note: to minimize this widget, the user must tap twice on the line corresponding to the selected Wi-Fi, otherwise another Wi-Fi will be selected.

The list can be ordered by SSID, BSSID, channel name, frequency, encryption type or signal level, the user just has to tap on the header of the corresponding column.

9.2.2.1.- Main window

Tap on the column header to order the list according to that parameter

Tap on the Wi-Fi to select it

SSID	BSSID	CH	Freq	Encryption	L1 (dBm)
Gsertel-Guest	12:da:43:c3:4a:d8	6	2437	WPA2	-51
triton-mesh-1	e2:ae:76:8a:bd:06	6	2437	WPA2	-55
gsertel-radius	10:da:43:c3:4a:d8	6	2437	WPA2	-59
GL-AR150-17a	eb:95:6e:4f:01:7a	6	2437	WPA2	-60
Ladatel_2_4	ac:22:0b:d2:c8:a8	5	2432	WPA WPA2	-60
GL-AR150-50b	eb:95:6e:41:e5:b8	6	2437	WPA WPA2	-61
Nighthawk	ae:63:91:38:de:a7	1	2412	WPA2	-62
H8BEVOLUTION-051917992...	3c:a3:88:b9:4c:e7	5	2432	WPA2	-67
triton_2_4G	3c:37:86:71:49:6e	6	2437	WPA2	-67
RUT240_B87C	02:1e:42:22:b0:7c	1	2412	WPA2	-67
RUT950_69AD	02:1e:42:22:69:ab	6	2437	WPA2	-72
V40_Thin0_5B	3a:30:19:eb:79:22	4	2427	WPA2	-68
dd-wrt	c8:56:27:1d:9d:00	6	2437	WPA2	-69
Ladatel-Guest	c8:56:27:24:c2:3a	11	2462	WPA2	-70
Tradesc_Guest	7a:10:13:da:01:36	11	2462	WPA2	-73

9.2.1- Wi-Fi measurements

This feature shows all the measurements of the Wi-Fi network selected by the user.

The default selected Wi-Fi network is the first in the Wi-Fi list. To select another Wi-Fi, you must maximize the Wi-Fi List widget (see section 10.2.1.- Wi-Fi List), or the Channel Map widget (see section 10.2.4.- Channel Map)

9.2.1.1.- Main window

The screenshot shows the main window of the MOSAIQ6 analyzer. At the top, there are two callout boxes: "Status and level measurement" pointing to the top-left area showing "Level: -61 dBm" and "Status: Unlocked"; and "Wi-Fi network parameters" pointing to the top-right area showing SSID "triton-mesh-1", BSSID "e2:ae:76:8a:bd:0d", CH "6 2437 MHz", and Encryption "[WPA2-PSK-COUP][TKIP]". Below this is a line graph showing signal level over time. A blue vertical marker is positioned at 10:59:42. A callout box at the bottom says "Level measurement historial during a time interval selected by the user. Drag to move the blue marker".

9.2.3.1.- Main window

The screenshot shows the main window with a "Time Graph" view. At the top, there are two callout boxes: "You can select the Wi-Fi networks that you want to see in the graph" pointing to a list of 10 Wi-Fi networks with colored selection buttons; and "Select/unselect all the networks" pointing to "Deselect All" and "Select All" buttons. Below is a multi-colored line graph showing the level measurement history for these networks. A callout box at the bottom says "History of the level measurement during an interval selected by the user".

9.2.1.2.- Contextual options menu

The screenshot shows the "OPTIONS" menu overlaid on the main window. It includes a "Clear" button, a "Last" dropdown menu currently set to "10 min", and a graph showing a level measurement of -57 dBm at 13:42:23. The background shows network parameters for SSID "Gsertel-Guest", BSSID "12:da:43:c3:4a:db", CH "1 2412 MHz", and Encryption "[WPA2-PSK-COUP][TKIP]".

- Clear: resets the chart.
- Last: 10 min, ½ hour, ½ day, 1 day, 1 week. Allows you to select the time interval shown in the chart.

9.2.3.2.- Contextual options menu

The screenshot shows the "OPTIONS" menu with a list of network selection buttons: "triton_2.4", "triton_mesh1", "Brightpeak", "Labelled-Guest", "triton-test", "Arantia-Guest", "Room 130 A.B", "gsertel-radius", "gsertel-radius", and "Arantia_wifi". There are also "Deselect All" and "Select All" buttons at the top. The background shows a graph with a level measurement of -57 dBm at 14:03:44.

- Clear: resets the graph.
- Last: 10 min, ½ hour, ½ day, 1 day, 1 week. Allows select the time interval shown in the graph.

9.2.3- Time graph

This feature shows a graph with the level measurement historical of all the Wi-Fi networks detected by the MOSAIQ6.

9.2.4- Channel map

This feature shows a graph with the distribution of all the Wi-Fi networks detected by the MOSAIQ6.

When this feature is maximized, the user can select a Wi-Fi using the “up” and “down” arrow buttons of the device. The selected Wi-Fi will be shown in the foreground.

10.2.4.1.- Main window

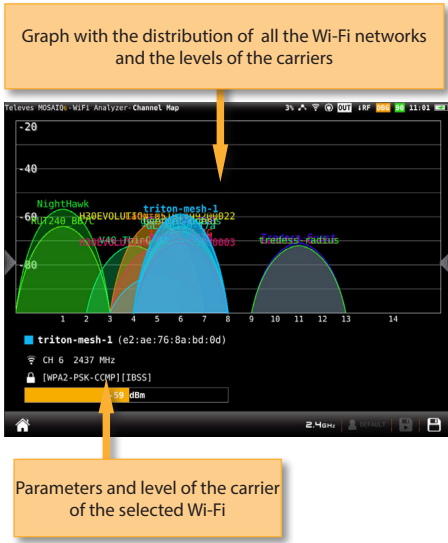

10. Network Tools

In this menu are grouped all the features that allow to check the network.

The screen corresponding to this feature is Mosaic4 type. This configuration has 4 widgets. All the widgets are user-configurable.

EN

10.1.- Main window



10.2.- Features

This section explains all the features available to visualize in Network Tools function.

10.2.1- Ping

This function attempts to connect to the server selected by the user. If the connection is established, the **MOSAIQ6** makes successive pings to the server and shows the delay times.

10.2.1.1.- Main window

Hexylon's network parameters

Orange icon if the ping is stopped
Green icon if the ping is running
Red icon if the connection to the server can not be established

IP address of the server. Tap to change. And packets loss measure

Start

ICMP_SEQ	TIME	STATUS
3	18 ms	1 ms
4	18 ms	1 ms
5	18 ms	1 ms
6	18 ms	1 ms
7	-	-
8	-	-
9	-	-
10	19 ms	1 ms
11	18 ms	1 ms

List of the successive pings

Tap to Start/Stop the ping

10.2.2.1.- Main window

Number of devices founded

Tap to start the scan

IP	MAC	MANUFACTURER
10.113.0.1	bc:3d:75:ae:24:06	Cisco
10.113.0.2	cc:0e:71:5c:93:c3	(Unknown)
10.113.0.13	08:0f:fe:fd:94:2b	G-PRO
10.113.0.14	08:0e:7c:42:02:ad	Televes
10.113.0.15	7c:01:01:01:7f:01	(Unknown)
10.113.0.16	18:33:15:50:08:11	(Unknown)
10.113.0.17	8c:c4:7a:7b:15:9c	Supgr
10.113.0.19	08:0e:7c:43:08:1b	Televes
10.113.0.26	c4:34:6b:66:43:0e	Hulett
10.113.0.28	08:e0:33:ae:88:76	E.E.P.D.
10.113.0.29	08:17c:42:06:2e	Televes
10.113.0.38	18:18:ad:03:22	ASUSTek
10.113.0.34	ae:13:11:01:00:17	Televes

List of devices with IP, MAC and manufacturer of each one

10.2.3- NMAP Scan

The NMAP (Network Mapper) Scan feature and gets information of the enabled ports and services of the device with the IP selected by the user.

10.2.2- ARP Scan

The ARP (Address Resolution Protocol) Scan feature scans the devices in the network and returns the IP, the MAC and the manufacturer of each one.

10.2.2.1.- Main window

Tap to edit the destination IP

Tap to start the scan

PORT	STATE	SERVICE
22 /TCP	Open	ssh
80 /TCP	Open	http
111 /TCP	Open	rpcbind
139 /TCP	Open	netbios-ssn
445 /TCP	Open	microsoft-ds
982 /TCP	Open	iss-realsecure
2049 /TCP	Open	nfs
111 /UDP	Open	rpcbind
123 /UDP	Open	ntp

List of ports with the state and the service of each one

10.2.3.1.- Main window

Orange icon while the test is running
Green icon if the speed is ok
Red icon if the speed is too low

Type of conecction

117 Mbps

443.39 Mbps (Download)
242.2 Mbps (Upload)

Tap to start test

Measures of down and upstream speeds

EN

10.2.4- Speed Test

This function attempts to connect to the server, checks the DHCP protocol and the connection to the Internet. Then, the MOSAIQ6 makes a download and upload speed test.



11. Drive Test

The Drive Test feature activates the GPS automatically. This is a suitable function to detect possible signal coverage problems in a specific area and find out what's causing it.

The screen corresponding to this feature is Mosaic3+1 type. This configuration has 4 widgets. All the widgets are user-configurable.

11.1.- Main window

Annotations for the main window:

- Tap on the top bar to select the widget feature
- Double-tap to see the feature screen in full screen

The screenshot shows the following data:

Status	Running	GPS	LOCKED	Last	DVB-T
#Channels	3	#Satellites	20	Power	78.6 dBuV
#Iterations	83	Latitude	42.864532 N/E	C/N	49.1 dB
Date	11/06/2019 12:47	Longitude	-0.568417 W/E	MER	37.1 dB
Time	00:06:56	Altitude	168 m	CBER	<1.0E-6
Next Measure	00:09:04	Speed	0 mch	VBER	<1.0E-8
		Locked	00:06:40		

Evolution graph showing signal strength over time.

Annotations for the control bar:

- Pause/Run the test
- Stop the test
- Select channels to measure

When you tap on "Sel Channels", a pop-up window will show all the plans of the selected channel plan, so you can select those that you want to check in the drive test:

Annotations for the 'Select Channels' dialog:

- Tap to select the channels to measure
- Select/Unselect all the channels

The dialog shows a grid of channel selection options:

S11	S12	S13	S14	S15	S16	S17
S18	S19	S20	S21	S22	S23	S24
S25	S26	S27	S28	S29	S30	S31
S32	S33	S34	S35	S36	S37	S38
S39	S40	S41	21	22	23	24
25	26	27	28	29	30	31
32	33	34	35	36	37	38

Once you tap on the Run button, you must select the name of the Drive Test File and the time interval between two consecutive measurements:

Annotations for the 'Save Drive Test Log' dialog:

- Edit file name
- Select time interval
- Save in a new directory
- Start Drive Test

The dialog shows the following configuration:

- New Drive Test Log: DriveLOG-0004
- Interval(Ss Max:Sh): [Slider]
- Log list: DriveLOG-0000, DriveLOG-0001, DriveLOG-0002, DriveLOG-0003
- Buttons: New Dir, Start, Cancel

Note that, if the time necessary to perform the measurements on all the selected channels is greater than the time interval, the time between one iteration and the next one will be the minimum necessary to perform the measurements in all the selected channels.

11.2.- Features

This section explains all the features available to visualize in Network Tools function.

11.2.1- Status

This function shows the current status of the test.

11.2.1.1.- Main window

Orange icon if the test is paused
Green icon if the test is running
Red icon if the test is stopped

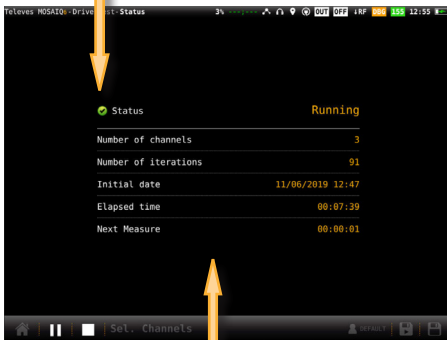

Number of channels: is the number of channels selected by the user to be measured in each iteration
Iterations: number of iterations of the test made from the start to now
Initial date: date when the test began
Elapsed time: time elapsed from the start date to now

11.2.2- GPS

This function shows all the information of the GPS.

11.2.2.1.- Main window

Green icon if the GPS is locked
Red icon if the GPS is unlocked

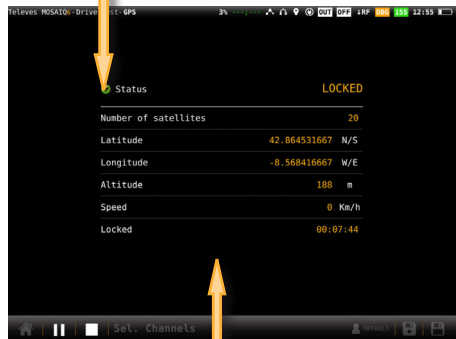

Number of satellites is the number of locked satellites
Latitude, Longitude, Altitude: GPS measures
Locked: is the time elapsed since the last time the GPS is locked

11.2.3.- Last

This function shows the current measurements obtained by the HEXYLON during the drive test.

11.2.3.1.- Main window

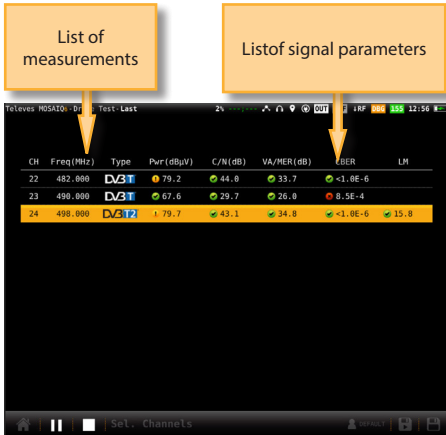

11.2.4- Evolution

This function shows the time evolution of the selected channel measurements obtained by the HEXYLON during the drive test, as well as the current measurements in all the channels. The window is similar to the one of the section 6.4.3.- Measurements

11.2.4.1.- Main window

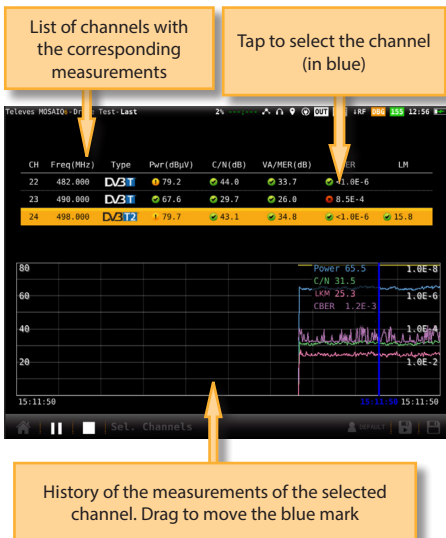

12. LOGS

The MOSAIQ6 saves two types of measurements files: LOGs and MacroLOGs.

A **LOG** saves all the measurements on the screen, as well as a screenshot. To save a LOG, tap on the icon in the bottom bar.

A **MacroLOG** is a scheduled measurement that the meter repeats automatically in a time interval selected by the user.

To schedule a MacroLOG tap on icon in the bottom bar.

Then a popup window will be open, where you can select the time interval. Then tap on the Start button:

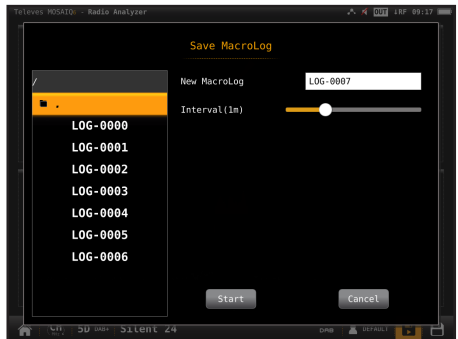

The meter makes and saves the measurements in each specified time interval until the user taps on Stop button.

Tap on Stop to stop the MacroLOG



•Screenshot: shows a screenshot of the meter exactly as it is at the measurement time.

If you select a MacroLOG, you can also select the measurement iteration:

Drag to see the scheduled measurement iteration



EN

The LOGs feature allow us to see all the LOGs and MacroLOGs stored in the meter.

12.1.- Main window

Stored LOGs Tap to select

Two views: Measurement and screenshot



Saves LOG in USB memory

Creates a new directory

Renames LOG

Deletes LOG

For each LOG, there are two views:

•Measurement: shows a list with all the measurements

Web application

To access your MOSAIQ6 web application, you must type the IP of your meter in the address bar of your web browser (Chrome recommended).

To know the IP of your meter, you must access to the top menu and select Network feature (see section *Settings in Top menu*).

The first time that you access to the web application you must use the following user and password:

User: admin

Password: admin

Then the web application will be open, showing the Resume window:



1.- Measurements

This feature shows all the LOGs and MacroLOGs stores in the meter.

There are two display modes:

- Calendar: the measurements are shown grouped by date in a calendar:

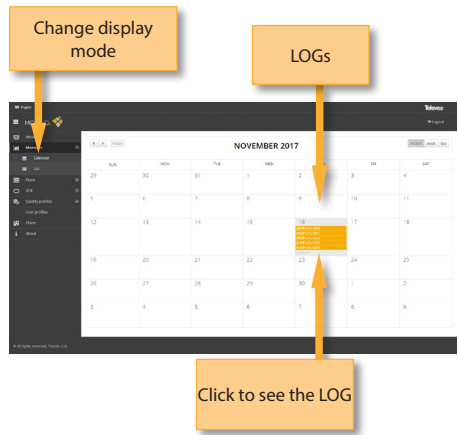

•List:

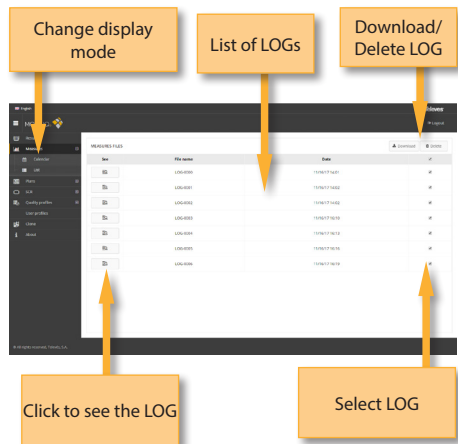

Once the LOG is selected, we see a window with all the information:

Using the buttons placed at the top right of the screen, you can remove the selected LOGs or download them to your computer in .xls format (it will be generated a .xls file for each LOG and they all will be downloaded together in a .zip file).

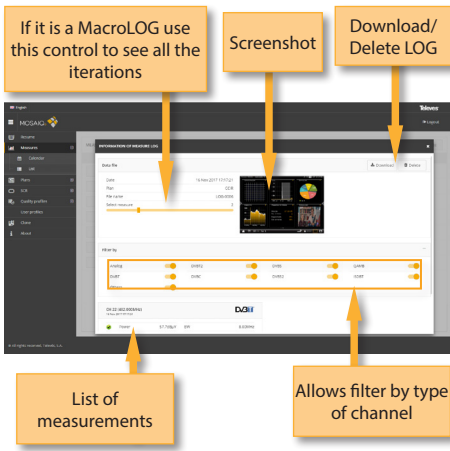

If the MacroLOG has, in addition, GPS information, you can see all the measurements iterations placed in a map in the position where they was made, so you have a detailed mapping and coverage analysis.

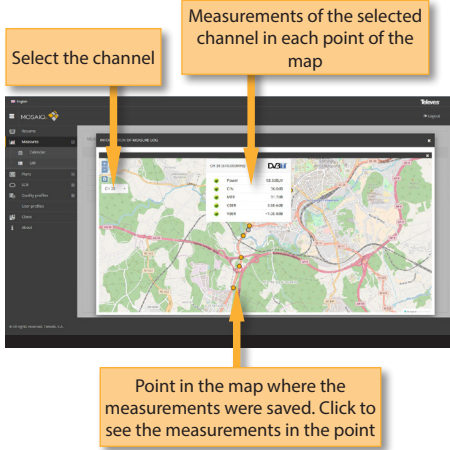

The Terrestrial and Satellite channel plan are the standard channel plans of the corresponding band. These plans can be removed from the meter, but they can not be edited. However, you can make a copy of one of them to build a new customer channel plan from it. The duplicated plans will appear in the Customer list automatically..

EN

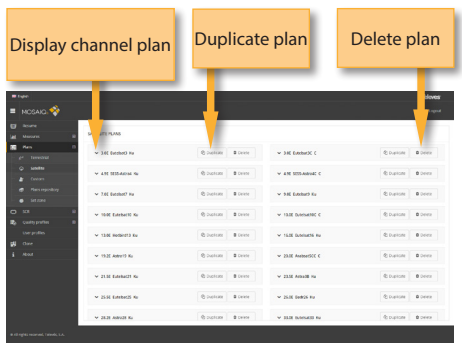

Customer channel plans can be edited:

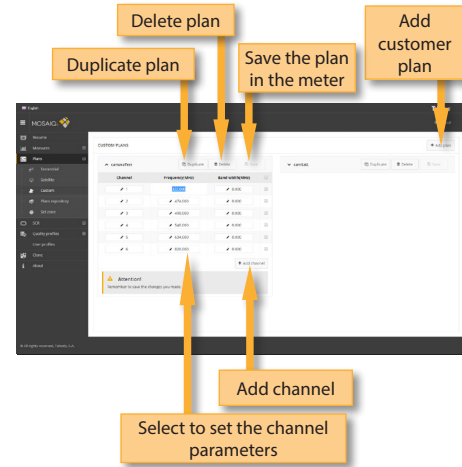

2. Plans

In this window, you can see all the channel plans of your H30FLEX. They are grouped in three categories: Terrestrial, Satellite and Customer.

The application also allows to configure the channel plans according to the geographic area you will use the meter.

The user can select the channel plans using the feature Repository. In this window you can see all the channel plan grouped by zones.

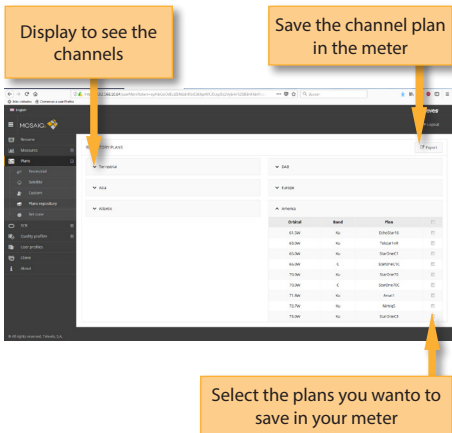

You can also upload to your meter the channel plans of a geographical zone automatically. To do that use the feature Set zone. In this window you can see a map of the world, and you can select the area where you will use the meter by clicking on it. With this and considering the language selected in your meter, the MOSAIQ6 will select automatically the channel plans both in terrestrial and satellite bands.

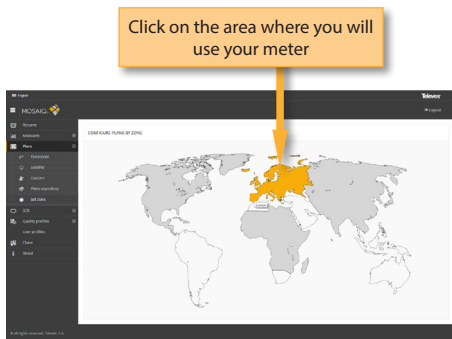

3. SCR

In this window, you can setup the multiswitches. The H30FLEX includes a list of multiswitches by default, but you can add more or edit any of the existing ones.

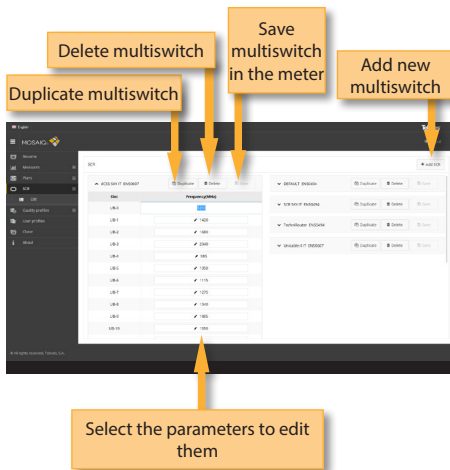

4. Quality profiles

Using the web application you can add new quality profiles. The MOSAIQ6 has two predefined quality profiles (head-end and outlet) that can not be edited, but they can be duplicated. The duplicated quality profiles are saved in the custom quality profiles, and the custom quality profiles can be edited.

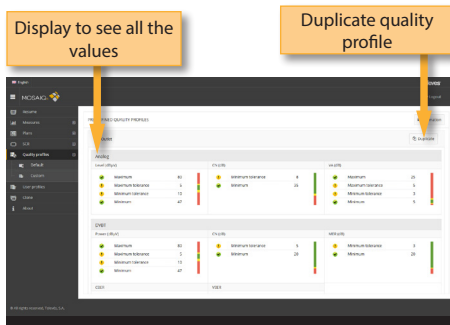

Custom quality profiles can be edited:

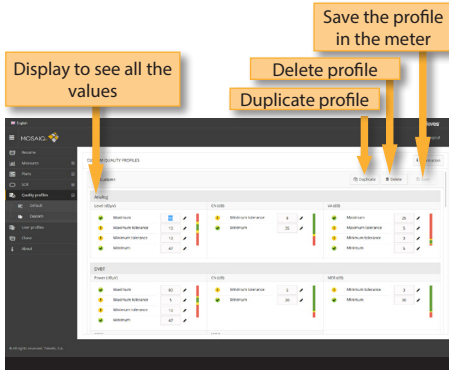

5. User profiles

Using the web application you can add new user profiles. The Hexylon has one pre-defined user profile (named Default) that is configured automatically according to the geographical area selected by the user.

For each user profile, the user must select the band (or bands) that he or she wants to use in that profile, as well as the channel plan for each band other appropriate parameters, depending on the band.

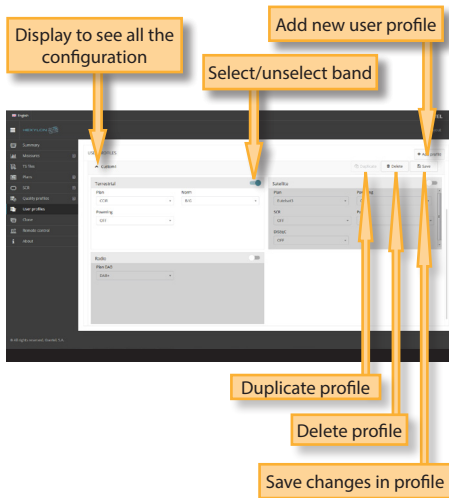

6. Clone

Using this feature it is very easy to have the same configuration in all your Hexylon meters. You only have to export the configuration of the Hexylon that you want to copy, using the Export feature. So, the configuration will be saved in a file on your computer.

Then, connect other Hexylon where you want to copy the configuration to and select the Import feature.

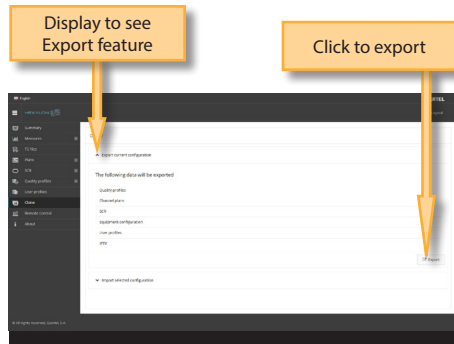

7. Licenses

Please contact the agents of our commercial network to purchase the license you wish at any moment. You will receive an e-mail with an attached file that you must save in your computer.

Then select this feature to activate the license by dragging the file into the corresponding box that is shown on the screen, or find the file in your computer.

Finally click on the Update button, the license will be activated in your **MOSAIQ6**.

8. Remote control

Using this feature you can control your Hexylon remotely. For this to work, it is necessary that the Hexylon and the computer are connected to the same LAN.

To access to this feature you must enter the password admin in the right top part of the window. Then you will see the screen of the Hexylon in your computer:



Using the mouse you can control the Hexylon as with the hands, except the pinch/spread gestures.

9. Configuration

This feature allows you to restore the factory settings of your MOSAIQ6.

When you do that, all the measurements, TS recordings, channel plans, quality and user profiles stored in your meter will be deleted.

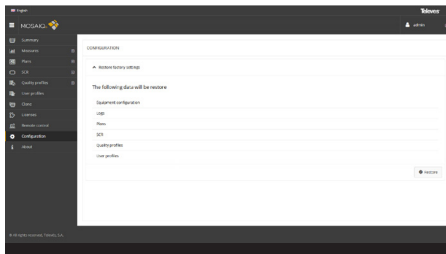

Cloud Repository

By registering your MOSAIQ6 on our website (see *Before Starting* section), you will be able to benefit from the cloud repository.

To access your repository in the cloud, just put the following IP address in the bar of your browser: XXXXX.XXX

To access you must use the username and password you used for registration on our website.

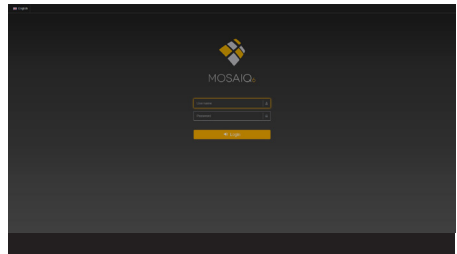

Once you enter your repository, you will see a list of all the meters you have registered:

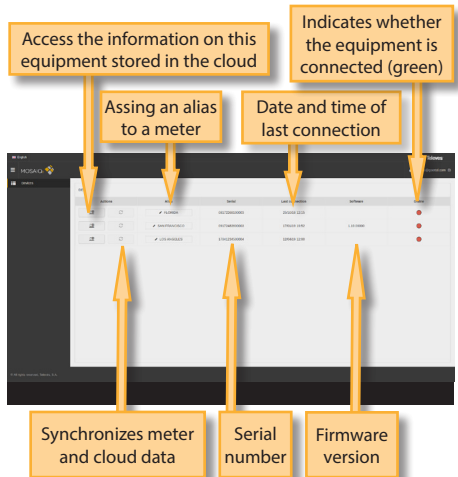

By clicking on one of the buttons on the left of the list, you can access the information in the cloud of that meter (it is not necessary for the device to be connected). You will then see a window similar to

that of the Web Application (see *Web Application* section):



Using the menus on the left of the window, you can view all the data for the selected meter, but you cannot edit it:

Model	PowerSupply	SerialNumber
110	100000	1000
110	100000	1000
110	100000	1000
110	100000	1000
110	100000	1000
110	100000	1000
110	100000	1000
110	100000	1000
110	100000	1000
110	100000	1000
110	100000	1000
110	100000	1000
110	100000	1000
110	100000	1000
110	100000	1000
110	100000	1000
110	100000	1000
110	100000	1000

Error messages

LOW BATTERY

Indicates that the battery is about to finish. The battery icon is red now. It is recommended to connect the meter to the external power source.

LOW BATTERY

Shutting down Some time after the LOW BATTERY message appears (time varies depending on the functions used), it will appear this message. If the meter is not connected to the external power source, it will switch off.

BAD POWER

Unplug power source This message appears when the meter is connected to an external power source that does not supply it the right power. Please, use only the power source provided with the H30FLEX.

SHORT-CIRCUIT

Check installation

This message appears when the meter detects a short-circuit at the RF input. It is recommended to check the installation to find out why the short circuit is produced.

DC OUTPUT LIMIT EXCEED

Switch DC OUTPUT off

This message appears when the meter detects an excessive consumption from the device that is being powered. It is recommended to turn off the powering feature of the MOSAIQ6.

DC AT RF INPUT

Check installation

This message appears when the meter detects DC at the RF input that is not generated by the MOSAIQ6. It is recommended to check the installation.

Maintenance

Always disconnect the unit before cleaning. Use only a mild solution of detergent and water applied with a soft damp cloth. Dry thoroughly before use.

Do not use aromatic hydrocarbons or chlorinated solvents. These products may damage the unit.

Do not use alcohol or alcohol based products on the front panel, especially the display.

These products may damage the unit.

Technical support

For any questions, contact Technical Support at www.televes.com

Before contacting Technical Support for repair, read the manual to ensure proper use and attempt to RESET the unit to clear any problems.

Repair service

Do not return the unit without first contacting Televes Technical Support.

If the unit needs to be returned, Televes will arrange for free shipping. The unit will need to be appropriately packed for shipping.

In compliance with IATA Regulations, when using our shipping service follow these instructions:

- Label the package.
- The equipment should fit as snugly as possible in the box. It is recommended to use the original packing materials.
- Attach the precaution label to the package.



Failure to comply with these shipping requirements may result in the shipping agent rejecting the package.

Warranty

Televes warrants, only to the original Purchaser, for a period of one (1) year from the date of original purchase, unless otherwise specified.

For the battery, due to the nature of the product, the warranty period is six (6) months.

Keep the purchase invoice to determine the warranty start date.

During the warranty period, Televes S.A. assumes any defect in materials or workmanship.

This warranty excludes any inoperability resulting from improper use, wear, service or repair performed by any third party not authorized, catastrophes or any cause unrelated to Televes S.A.

DECLARACIÓN DE CONFORMIDAD ▪ DECLARATION OF CONFORMITY ▪
DECLARAÇÃO DE CONFORMIDADE ▪ DECLARATION DE CONFORMITE
▪ DICHIARAZIONE DI CONFORMITÀ ▪ DEKLARACJA ZGODNOŚCI ▪
KONFORMITÄTSEKTLÄRUNG ▪ ΠΙΣΤΟΠΟΙΗΤΙΚΟ ΣΥΜΜΟΡΦΩΣΗΣ ▪
FÖRSÄKRAN OM ÖVERENSSTÄMMELSE ▪ ДЕКЛАРАЦИЯ СООТВЕТСТВИЯ ▪
ةقباطملا نايب ► <https://doc.televes.com>

European technology **Made in**  **EU**rope