

## LWO-SFP-3155-40

1.25 Gbit SFP BiDi, 1310nmTX/1550nmRX, 40km, DDM, LC-Simplex, Singlemode

### Features

- SFP package with LC connector
- 1310nm FP Laser and 1550nm PIN photodetector
- 1550nm DFB Laser and 1310nm PIN photodetector
- Up to 40Km transmission on SMF
- +3.3V single power supply
- LVPECL compatible data input/output interface
- Low EMI and excellent ESD protection
- Laser safety standard IEC-60825 compliant
- Compatible with RoHS
- Compatible with SFF8472

### Application

- 1.25Gb/s 1000Base-LX Ethernet
- 1.06 Gb/s Fibre Channel Fiber Channel



### Absolute Maximum Ratings

Parameter	Symbol	Min	Typical	Units
Storage Temperature	Tst	-40	+85	°C
Supply Voltage	Vcc	0	+3.6	V
Operating Relative Humidity	RH	5	95	%

### Operation Environment

Parameter	Symbol	Min	Typical	Max	Units
Supply Voltage	Vcc	3.15	3.3	3.45	V
Operating Case Temperature	Tc	0		+70	°C
Power Dissipation				1	W
Data Rate			1.25		Gbps

### Optical Characteristics 1/2 (Ambient Operating Temperature 0°C to +70°C, Vcc = 3.3 V)

Parameter	Symbol	Min.	Typ.	Max.	Units	
<b>Transmitter Section</b>						
Center Wavelength	Tx 1310	$\lambda_o$	1260	1310	1360	nm
	Tx 1550		1540	1550	1560	
Spectral Width (RMS)	Tx 1310	$\Delta\lambda$	-	-	4	nm
	Tx 1550				1	
Average Output Power	Tx 1310	Po	-5	-	0	dBm
	Tx 1550		-5		0	
Extinction Ratio		Er	8	-		dB
Rise/Fall Time (20%~80%)		Tr/Tf			300	ps
Total jitter		Tj			0.43	UI
Optical Eye Diagram	IEEE 802.3z and ANSI Fibre Channel Compatible					

## LWO-SFP-3155-40

### 1.25 Gbit SFP BiDi, 1310nmTX/1550nmRX, 40km, DDM, LC-Simplex, Singlemode

#### Optical Characteristics 2/2 (Ambient Operating Temperature 0°C to +70°C, Vcc = 3.3 V)

Parameter	Symbol	Min.	Typ.	Max.	Units	
<b>Receiver Section</b>						
Center Wavelength	Rx 1550	$\lambda_o$	1500	1550	1600	nm
	Rx 1310		1260	1310	1360	
Receiver Sensitivity	Rsen			-24	dBm	
Receiver Overload	Rov	-3			dBm	
Return Loss	12			dB		
LOS Assert	LOS <sub>A</sub>	-36			dBm	
LOS Dessert	LOS <sub>D</sub>			-25	dBm	
LOS Hysteresis		0.5		5		

#### Electrical Characteristics (Ambient Operating Temperature 0°C to +70°C, Vcc = 3.3 V)

Parameter	Symbol	Min.	Typ.	Max.	Unit
<b>Transmitter Section</b>					
Input Differential Impedence	Zin	90	100	110	Ohm
Data Input Swing Differential	Vin	500		2400	mV
TX Disable	Disable	2.0		Vcc	V
	Enable	0		0.8	V
TX Fault	Assert	2.0		Vcc	V
	Deassert	0		0.8	V
<b>Receiver Section</b>					
Output differential impedance	Zout		100		Ohm
Data Input Swing Differential	Vout	370		2000	mV
Rx_LOS	Assert	2.0		Vcc	V
	Deassert	0		0.8	V

#### EEPROM INFORMATION (A0) 1/2

Addr	Field Size (Bytes)	Name of Field	HEX	Description
0	1	Identifier	03	SFP
1	1	Ext. Identifier	04	MOD4
2	1	Connector	07	LC
3-10	8	Transceiver	00 00 00 02 12 00 0D 01	Transmitter Code
11	1	Encoding	01	8B10B
12	1	BR, nominal	0D	1250M bps
13	1	Reserved	00	
14	1	Length (9um)-km	28	40km
15	1	Length (9um)	64/C8/FF	
16	1	Length (50um)	00	
17	1	Length (62.5um)	00	
18	1	Length (copper)	00	
19	1	Reserved	00	

## LWO-SFP-3155-40

1.25 Gbit SFP BiDi, 1310nmTX/1550nmRX, 40km, DDM, LC-Simplex, Singlemode

### EEPROM INFORMATION (A0) 2/2

Addr	Field Size (Bytes)	Name of Field	HEX	Description
20-35	16	Vendor name	4C 49 47 48 54 57 49 4E 20 20 20 20 20 20 20 20	LIGHTWIN
36	1	Reserved	00	
37-39	3	Vendor OUI	00 00 00	
40-55	16	Vendor PN	xx xx xx xx xx xx xx xx xx xx xx xx xx xx xx xx	ASC II
56-59	4	Vendor rev	31 2E 30 20	V1.0
60-61	2	Wavelength	05 1E/06 0E	1310nm/1550nm
62	1	Reserved	00	
63	1	CC BASE	XX	Check sum of byte 0~62
64-65	2	Options	00 1A	LOS, TX_DISABLE, TX_FAULT
66	1	BR, max	32	50%
67	1	BR, min	32	50%
68-83	16	Vendor SN	00 00 00 00 00 00 00 00 00 00 00 00 00 00 00 00	Unspecified
84-91	8	Vendor date code	XX XX XX 20	Year, Month, Day
92-94	3	Reserved	00	
95	1	CC_EXT	XX	Check sum of byte 64~94
96-255	160	Vendor specific		

### Diagnostics

Parameter	Range	Accuracy	Unit	Calibration
Temperature	0 ~ 70	±5	°C	Internal
Voltage	3.15 ~ 3.45	±0.1	V	Internal
Bias Current	10 ~ 80	±10%	mA	Internal
Tx Power	-5 ~ 0	±3	dBm	Internal
Rx Power	-26 ~ -3	±3	dBm	Internal

### Pin Description 1/2

Pins	Name	Discription	NOTE
1	VeeT	Transmitter Ground	
2	Tx Fault	Transmitter Fault Indication	1
3	Tx Disable	Transmitter Disable	2
4	MOD DEF2	Module Definition 2	3
5	MOD DEF1	Module Definition 1	3
6	MOD DEF0	Module Definition 0	3
7	Rate Select	Not Connected	
8	LOS	Loss of Signal	4
9	VeeR	Receiver Ground	
10	VeeR	Receiver Ground	
11	VeeR	Receiver Ground	
12	RD-	Inv. Received Data Output	5

## LWO-SFP-3155-40

### 1.25 Gbit SFP BiDi, 1310nmTX/1550nmRX, 40km, DDM, LC-Simplex, Singlemode

#### Pin Description 2/2

Pins	Name	Description	NOTE
13	RD+	Received Data Output	5
14	VeeR	Receiver Ground	
15	VccR	Receiver Power	
16	VccT	Transmitter Power	
17	VeeT	Transmitter Ground	
18	TD+	Transmit Data Input	6
19	TD-	Inv. Transmit Data Input	6
20	VeeT	Transmitter Ground	

#### Notes

- TX Fault is an open collector output, which should be pulled up with a 4.7k~10kΩ resistor on the host board to a voltage between 2.0V and Vcc+0.3V. Logic 0 indicates normal operation; logic 1 indicates a laser fault of some kind. In the low state, the output will be pulled to less than 0.8V.
- TX Disable is an input that is used to shut down the transmitter optical output. It is pulled up within the module with a 4.7k~10kΩ resistor. Its states are:  
Low (0~0.8V): Transmitter on (>0.8V, <2.0V): Undefined  
High (2.0~3.3V): Transmitter Disabled Open: Transmitter Disabled
- MOD-DEF 0,1,2 are the module definition pins. They should be pulled up with a 4.7k~10kΩ resistor on the host board. The pull-up voltage shall be VccT or VccR.  
MOD-DEF 0 is grounded by the module to indicate that the module is present  
MOD-DEF 1 is the clock line of two wire serial interface for serial ID  
MOD-DEF 2 is the data line of two wire serial interface for serial ID
- LOS is an open collector output, which should be pulled up with a 4.7k~10kΩ resistor on the host board to a voltage between 2.0V and Vcc+0.3V. Logic 0 indicates normal operation; logic 1 indicates loss of signal. In the low state, the output will be pulled to less than 0.8V.
- These are the differential receiver output. They are internally AC-coupled 100Ω differential lines which should be terminated with 100Ω (differential) at the user SERDES.
- These are the differential transmitter inputs. They are AC-coupled, differential lines with 100Ω differential termination inside the module.

## LWO-SFP-3155-40

1.25 Gbit SFP BiDi, 1310nmTX/1550nmRX, 40km, DDM, LC-Simplex, Singlemode

### Recommended Application Circuit

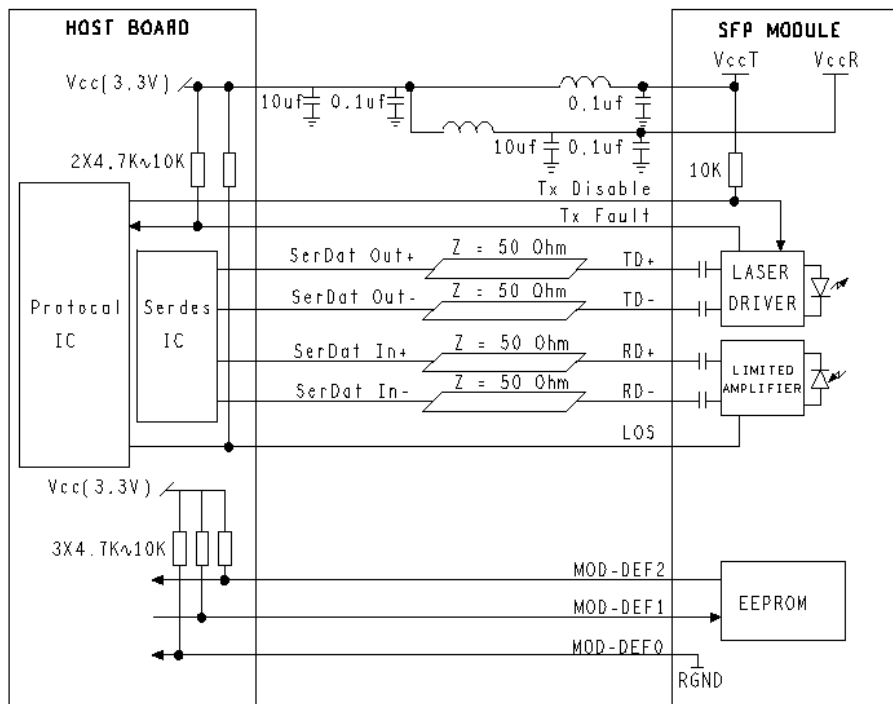

### Recommended Application Circuit

